















STARTER



















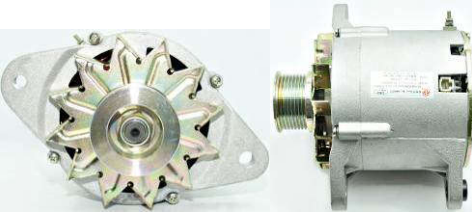

<p>0001-368-309 24V 9 teeth Mercedes</p> 	<p>0001-417-001 24V 9 teeth Daewoo & Mercedes</p> 	<p>8200330 39MT 24V 11 teeth Cummins</p> 
<p>0350-552-0311, 28100-1700 24V 11 teeth Hino</p> 	<p>27486 12V 10 teeth M45 model Perkin</p> 	<p>228000-2120, 28100-54380 12V 10 teeth Toyota 3L</p> 
<p>0-23000-3153, 600-813-4533 24V 12 teeth Komatsu</p> 	<p>Part No: AZE4202 12V 11 teeth Deutz</p> 	<p>S114-925B 12V 13 teeth Opel Combo</p> 
<p>M8T80071 24V 9teeth Mitsubishi 4D43, 4D34-36</p> 	<p>S24-03C, 8-94333-438-0 24V 9 teeth Isuzu 4BC2</p> 	<p>S115A24-11M 24V 11 teeth Cummins</p> 
<p>Part No:0-24000-3032 24V 11teeth Isuzu</p> 	<p>128000-5732 24V 10teeth Caterpillar</p> 	<p>10478998 24V 11teeth Caterpillar, Cummins</p> 

<p>03111-4200 12V 11teeth Kia K2700</p> 	<p>4944701 24V 10T Cummins</p> 	<p>MTU Starter 002-151-1801</p> 
<p>0350-602-0092 24V 11teeth RD8/RF8</p> 	<p>0-24000-3060 24V 10teeth Komatsu PC100-6</p> 	<p>S114-438A 12V 20teeth Yanmar</p> 

SAMPLE OF STARTER PARTS









<p>Armature RAS5135 24V</p> 	<p>Armature M106X43772 24V</p> 	<p>Yoke M800X70787 24V</p> 	<p>Field Coil 1945853 24V</p> 	<p>Starter Brush Holder 028510-0500</p> 
<p>Solenoid Switch SS2717 24V</p> 	<p>Solenoid Switch 0-47100-4402 24V</p> 	<p>Solenoid Switch 28150-77090 24V</p> 	<p>Clutch M357X73571</p> 	<p>Pinion 2240-8501 11 teeth</p> 
<p>Bush for Starter</p> 	<p>Terminal Kit for Starter and Alternator</p> 	<p>Lever 23623</p> 	<p>Starter Relay U001T07079</p> 	<p>Starter Carbon JNKSX28</p> 

ALTERNATOR

<p>0-35000-3872 24V 40A Isuzu 4BG1 6BG1</p> 	<p>110-459, 8LHA3096U 24V 110A</p> 	<p>96540541 12V 85A Chevrolet Aveo</p> 	<p>0120-689-535 24V 140A Mercedes</p> 
<p>A002TN0499BT 12V 65A Mitsubishi L300</p> 	<p>66021626A 24V 55A Cummins</p> 	<p>LR1100-502 12V 100A Opel Combo</p> 	<p>24158D 12V 65A Perkins Lucas</p> 
<p>GP9926 12V 20A Denyo</p> 	<p>LR160-446E 12V 60A Isuzu</p> 	<p>A14N118M, 24V 60A Volvo Penta</p> 	<p>102211-2820 24V 35A Komatsu</p> 
<p>C4988377 24V 45A Cummins</p> 	<p>63377466 24V 75A Perkins</p> 	<p>AAK1189 12V 65A Deutz</p> 	<p>104210-4980 12V 150A Toyota Estima</p> 
<p>0214-501-0316 24V 20A Hino W04DT</p> 	<p>A002TC0691A 12V 90A Honda</p> 	<p>100213-1730 12V 70A Toyota 3L</p> 	<p>104210-5450 12V 130A Toyota Hiace</p> 

<p>OK9B1-18-300 Kia Alternator</p> 	<p>A13N281 Hatz Alternator</p> 	<p>002-235-4101 MTU Alternator</p> 	<p>0-35000-8670 Isuzu Bus 24V 140A</p> 
<p>8600232 36SI 24V 105A</p> 	<p>0201-102-2973 24V 60A Nissan RG8</p> 	<p>A004TR5392ZTDM 24V 90A Volvo Renault</p> 	<p>02121-9021 12V 60A Kia K2700</p> 
<p>37300-22650 12V 90A Hyundai Traiet</p> 	<p>0124-555-008 24V 80A Scania</p> 	<p>LR160-728E 12V 60A Nissan Cabstar TD27</p> 	<p>0-33000-2280 24V 13A Komatsu S4D130</p> 

SAMPLE OF ALTERNATOR SPARE PARTS

<p>Regulator/Rectifier 0-33730-2560 24V</p> 	<p>Rectifier 021580-2160</p> 	<p>Regulator A866X25572</p> 	<p>Alt Brush Holder 021620-2870</p> 	<p>4210-4450 Pulley with Clutch</p> 	<p>Bearings for Alternator</p> 	<p>Stator 11300N</p> 
<p>Rotor 103765</p> 	<p>Socket for Denso Alt. (Oval Type) C. ND 3M</p>  <p>N/T</p>	<p>Socket for Denso Alt. (Oval Type) C. ND 3F N/T</p> 	<p>Socket for Denso Alt. (Round Type) C. ND. 3M</p> 	<p>Socket for Denso Alt. (Round Type) C. ND. 3F</p> 	<p>Socket for Alternator C. HIT 2M</p> 	<p>Socket for Alternator C. MIT 4F N/T</p> 

DIODES

D...MB5010 50amp 	D.DWR100A-40-A V V V 	Diode for Welding Machine 	Diode for Denso Alternator 43206 	7321-9372-90 	D.1amp D.3amp D.6amp 
Diode for Bosch Alternator 	Diode for Delco Remy Alternator 	Diode for Hitachi / Denso Alternator 	Diode for Denso Alternator D.SG9 	Diode for Denso Alternator (High Ampere) D.SG9L 	D.TS11/12 
Diode Mitsubishi Alt 	Diode for Leece Neville Alternator 2-57 (+) 2-58 (-) 	KM Diode 	Diode for Denso Alternator D.SG6 (+) D.SG7 (-) 		

FUEL PUMP

FPL-1201 12V FPL-2401 24V 	UC-V4 12V 	MM20054201 12V, MM20054202 24V 	375-01015 24V 	UC-J7 12V 
---	---	---	---	---







FLASHER UNIT

Part No: 066500-2150 24V 	Part No: 1622411 12V 	Part No: 1628821 12V/24V 	P/No: VF324L 24V, VF312L 12V 	Part No: 066500-1521 24V 	Part No: 25390-00z0B 24V 
---	---	--	---	---	---

MOTOR

<p>Hydraulic Motor: MEB-5001 24V</p> 	<p>Hydraulic Motor AMJ5196 24V 2.2KW</p> 	<p>Hydraulic Motor AME1629 24V 0.5KW</p> 	<p>Hydraulic Motor AMJ4747 12V 1.6KW</p> 	<p>Hydraulic Motor AMJ5238 12V 1.6KW</p> 
<p>Oil Pump ED-12 (12V), ED-24(24V)</p> 	<p>Washer Pump Motor WP24-180B12 (24V)</p> 	<p>Blower Motor P/No: 162500-6660 , 162500-5461 24V</p> 	<p>Wiper Motor 159100-9480 24V</p> 	<p>DC Motor 0-52000-5180 350W 36/48V</p> 
<p>Wiper Motor 849100-4350 24V</p> 	<p>Wiper Motor 059100-4290 24V</p> 	<p>Wiper Motor 159100-8152 24V</p> 	<p>Oil Pump With Filter UP3 24V, UP6 12V</p> 	<p>862100-4630 POWER WINDOW MOTOR (LH) 24V</p> 

Blower Motor

 <p>Blower Motor Reversible 3700RPM</p> <p><u>Part Number</u> Description BM-4201 24V</p>	 <p>Blower Motor CW 4650RPM L=240mm</p> <p><u>Part Number</u> Description BM-4402 24V</p>	 <p>Blower Motor 4000RPM</p> <p><u>Part number</u> description BA-4409S 24V</p>
 <p>Brushless Blower motor</p> <p><u>Part number</u> description BB-11014 24V</p>	 <p>Blower Motor 3950RPM</p> <p><u>Part number</u> description BM-0968W 24V</p>	 <p>Blower Motor 3000RPM</p> <p><u>Part number</u> description BM-983AW 24V</p>

	Blower Motor 3100RPM
	<u>Part number description</u> BA-4406K

Prestolite Handraulic Parts

ACCUMULATOR Part No: 6518-24 	Handpump Part No: 6518-35 	Seal Kit Part No: 6518-39 	Handraulic Complete Starting System 1324005 
---	---	---	---

FAN



 <p>Fan Assemblies <u>Part NumberDescription</u> Push Type Pull Type RF-12S5H RF-12S5L 12V 12" RF-12S6H RF-12S6L 24V 12" RF-14S5H RF-14S6L 12V 14" RF-14S6H RF-14S6L 24V 14" RF-16S6H 24V 16"</p>	 <p>Fan Assemblies Available 12V & 24V Push Type <u>Part No Description</u> RF-1001 12V 10" RF-1101 12V 12" RF-1102 24V 12" RF-1402 24V 14"</p>	 <p>CAR FAN 12V & 24V <u>Part NumberDescription</u> ZF-M2 12V 8" ZF-M2 24V 8" ZF-M4 12V 6" ZF-M4 24V 6"</p>
 <p>Fan Assemblies <u>Part NumberDescription</u> (Push Type) EF-4001D 24V (Pull Type) EF-4001C 24V</p>	 <p>Fan Assemblies <u>Part NumberDescription</u> (Push Type) EF-5001D 24V (Pull Type) EF-5001C 24V</p>	 <p>Thermo switch for compressor <u>Part Number</u> R-1502</p>
 <p>Fan Assemblies <u>Part NumberDescription</u> (Pull Type) EF-8S61C 24V 16"</p>	 <p>Brushless Fan Assemblies Extra Long life <u>Part NumberDescription</u> (Push Type) BF-5051D 24V (Pull Type) BF-5051C 24V</p>	 <p>Fan Assemblies 8" <u>Part NumberDescription</u> EF-1002C</p>

OFF ENGINE SOLENOID SWITCH (MOST SWITCH ARE AVAILABLE IN BOTH 12V & 24V)







<p>SA-4343-24 1751ES-24RULB4S1</p>  <p>*bracket on opposite side is available</p>	<p>SA-3838 2003-24E7U1B1S2A</p> 	<p>1502-12C6U1B2S1 12V</p> 	<p>SA-4569 12V</p> 	<p>1503ES-3TNA72 12V</p> 
<p>SA-3796 1751-12E7U1B1S5</p> 	<p>SA-4124-24 1752ES-24A7UC3B1S5</p> 	<p>1756ES24E3ULB1S5 24V</p> 	<p>2001-24E3U1B2S2A 24V</p> 	<p>1823723C91 2003ES-24S2ULB5S4</p> 
<p>SA-4744-12 2003ES-12E6ULS2</p> 	<p>DF1502 12V</p> 	<p>3991624 (12V), 3991625 (24V)</p> 	<p>SA-4634-12 (12V) SA-4634-24 (24V)</p> 	<p>1503-12A4UC5S 12V</p> 
<p>5-81900-008-1 24V Cable 104cm</p> 	<p>600-815-6631 24V cable 160cm</p> 	<p>MV1-40 12V</p> 	<p>MV2-17 24V</p> 	<p>053400-0745 24V</p> 
<p>052600-1001 12V</p> 	<p>1502-12C2U1B2S1 12V</p> 	<p>263A-23 24V</p> 	<p>SK-1043-58 12V</p> 	<p>DH-7100 24V DH-7100 12V</p> 

GAUGE/METER

	<p>Water Temperature Gauge (Electrical) 12V MTE52CD120-2/ET-2 12V E52CD120-2/ET-2 24V MTE52CD120-3/ET-3 24V E52CD120-3/ET-3</p>		<p>Water Temperature Gauge (Mechanical) 3M MT52CD40-120 120" 52CD3.0M 50-120 4.5M MT52CD40-120 180" 52CD4.6M 50-120 5.5M 20T250-18-1/2 6.0M 52CD6.0M 50-120</p>		<p>Voltmeter 12V MTE52BL18V 24V MTE52BL36V</p>
	<p>Oil Pressure Gauge (Electrical) 12V 7bar MTE52CD7K-2/EO-2 12V 7bar E52CD7K-2/EO-2 24V 7bar MTE52CD7K-3/EO-3 24V 7bar E52CD7K-3/EO-3 24V10bar MTE52CD10K3/EO3 24V 10Bar NEO547</p>		<p>Oil Pressure Gauge (Mechanical) 10Bar MTO-10B 10Bar 20PHL150PSI 7Bar A20P100PSI plastic insulated 7Bar 20P100PSI metal grounded</p>		<p>Oil Temperature Gauge 12V E52CD140-2/ET-2 24V E52CD140-3/ET-3 24V 10.70.1317</p>
	<p>Hour Meter Dual Voltage 12/24V 6N5906 Hobbs 12/24V MT52CBH</p>		<p>Hour Meter 12-60V 85094 Hobbs 12-32V 85000 Hobbs</p>		<p>Meter Bracket Available in 1 hole & 2 holes BP1 1 hole (install 1 gauge) BP2 2 holes (install 2 gauges)</p>
	<p>Digital Hour Meter Dual Voltage 12-48V 98312</p>		<p>Digital Hour Meter cum Battery indicator w/ relay out function HB8550-R12V 12V HB8550-R24V 24V</p>		<p>Ampere Meter 30A AM-30AL w/light 30A MT52SL-30A 50A AM-50AL w/light 50A 52S-50A, 50A MT52SL-50A 60A 52S-60A 60A MT52SL-60A</p>
	<p>Fuel Gauge Gauge only 12V 52CDG-2I 24V 52CDG-3I Fuel Gauge assembly 12V 15.70.0514 24V 15.70.0515</p>		<p>Sending Unit for Fuel Gauge MT-UT UT</p>		<p>Sensor 4-116</p>

	<p>Tachometer/RMP Meter Alternator Driven Without Hour Meter 85mm 0-4000 RPM 108156 With Hour Meter 89mm 0-3000 RPM ATHA-30-24-C (Digital Hour) 85mm 0-4000 RPM 103684 80mm 0-3000 RPM 333-035-010G</p>		<p>Tachometer/RPM Meter Sensor Driven Without Hour Meter 85mm 0-4000RPM 12/24V 103665 With Hour Meter 85mm 0-3000RPM 12/24V 103680 89mm 0-3000RPM 12V ATS-30-12-C</p>		<p>Tachometer/ RMP Meter Mechanical 80mm 0-4000RPM MT305369 Inner Thread 80mm 0-4000RPM MT305372 Outer Thread 80mm 0-3000RPM 25050-90065</p>
---	---	---	--	--	---

METER

	<p>Digital Multi Meter (backlight & Temperature measurement) CD772 116x82x44mm Function: DC/AC Voltage, DC/AC current, Resistance, Capacitance, Frequency, Temperature, Continuity and Diode Test</p>		<p>Digital Multi Meter CD800A 176x104x46mm Function: DC/AC Voltage, DC/AC current, Resistance, Capacitance, Frequency, Duty Cycle, Continuity and Diode Test</p>		<p>Ampere Digital Multimeter (Clamp Meter) DCM400AD Function: AC/DC current, AC/DC Voltage, Resistance, Continuity</p>		<p>Analog Multi Meter YX360TRF160x129x42mm Function: DC/AC Voltage, DC current, Resistance, Load current, capacitance</p>
	<p>Pocket Digital Multi Meter PM11 Function: DC/AC Voltage, Resistance, Continuity and Diode Test</p>		<p>Battery Tester BT-100A 12V</p>		<p>Insulation Tester 4-4000M ohm testMG1000</p>		

KEY SWITCH

<p>Part No: 8S7713 3 pins</p> 	<p>Part No: HI660T 5 pins Nissan</p> 	<p>P/No: ISC-05 3 Screw</p> 	<p>P/No: 2479U346F2 6 pins</p> 	<p>P/No: 183920-91450 5 pins</p> 	<p>Part No: E138 6 pins Isuzu</p> 
<p>Part No: SS113 6 pins</p> 	<p>Part No: 084826F</p> 	<p>Part No: ST30</p> 	<p>Part No: EN520000 (ISC-9), EN521000 (ISC-10 w/heater)</p> 	<p>Part No: 08086-20000 6screws</p> 	<p>P/No: 9G7641 4 screw</p> 

P/No: 083-883-010 10pin switch 	Part No: DIS-3850 	P/No: 106100-77620 	P/No: KBZ-02 (0342-315-001) 	P/No: SS85 	P/No: Limit A22M-RS3 
Part No: 083-878-005 5 pins With start repeating lock 	P/No: SS1148 (start lock) 4pins 	75904-01 BATTERY SWITCH 	EN140000 Hook Wrench Tools (For Tightening Key Switch) 		

SWITCH

Toggle Switch
DC 12V 20A
Part Number

R13-29A	2 pins	ON-OFF
R13-29C	3 pins	ON-ON
R13-29D	3 pins	ON-OFF-ON
R13-29E	6 pins	ON-OFF-ON
R13-29F	4 pins	ON-OFF
R13-29G	3 pins	(ON)-OFF-(ON)
R13-29K	6 pins	ON)-OFF-(ON)

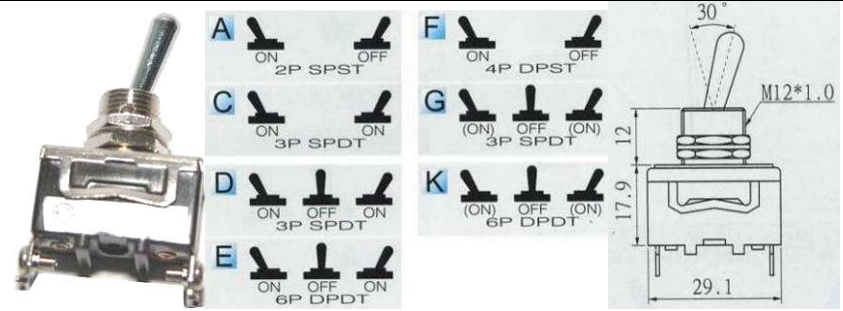

Toggle Switch
Water/Dust
IP56 Rating
DC 12V 20A
Part Number
R13-447C
3pins ON-ON

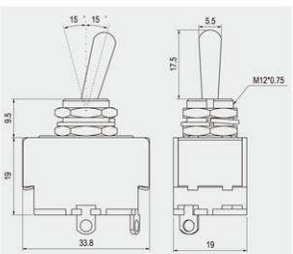

R13-28

Rating	15A 125V AC 10A 250V AC
Contact resistance	50mΩ Max
Insulation resistance	DC 500V 100MΩ Min
Dielectric strength	AC 1500V 1 minute
Cut-out	

FUNCTION TERMINAL

G	I	K	P	0 1	.250" SQ
				0 5	SO
				0 6	SC 3
				0 7	SC 4

* MATERIAL: Metal lever and bushing are nickel plated metal. Frame is metal plated steel. Terminals are nickel plated brass. Base is phenolic.

Toggle Switch
DC 12V 6A
Part Number
R13-37 3pins ON-ON

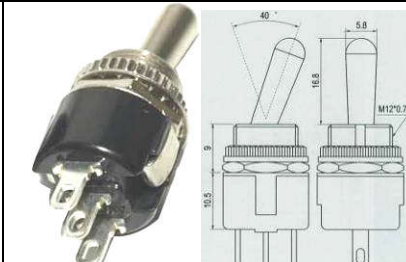









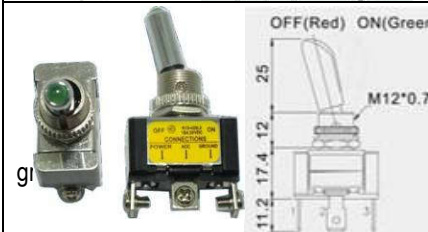



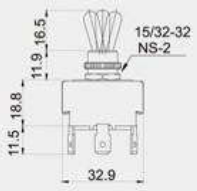

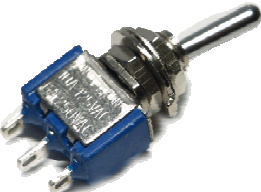

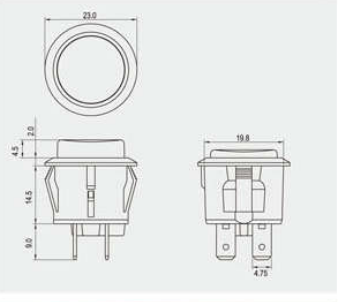

Toggle Switch
Part No

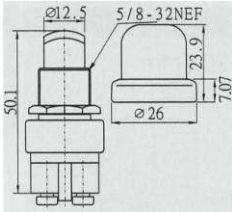
R13-28G-01	3 pins	(ON)-OFF-(ON)
R13-28I-01	3 pins	ON-(ON)
R13-28K-01	6 pins	(ON)-OFF-(On)
R13-28P-01	6 pins	ON-(ON)

Toggle Switch
with light
12/24V 3pins
Part NumberColour
R13-423L3-G



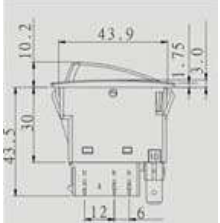

R13-423L3-R red
R13-423L3-Yyellow







  <p>Toggle Switch Part Number R13-438M01-07 6pins ON-OFF-(ON)</p>	<p>Rubber Boot for R13 Series Toggle Switch (Water Proof Cover) Part Number :R13-70B Boot</p> 	 <p>Plate for R13 Series Toggle Switch Part Number R13-29P ON-ON R13-29P ON-OFF-ON R13-29P ON-OFF</p>
 <p>Mini Toggle Switch Part Number TD102A1</p>	 <p>Cover for Mini Toggle Switch Part Number TD102W-G Green TD102W-R Red TD102W-W White TD102W-Y Yellow</p>	 <p>Safety Cover For Toggle Switch Part Number R17-10 Gloss Red R17-10 Dark Red</p>
  <p>Push Start Button Switch Part Number A2-23B Without light A2-23B-12VWith light 12V A2-23B-24VWith light 24V</p>	 <p>Push Button Switch Part Number PSQ-1</p>	  <p>Push Button Switch Part Number 12741</p>
  <p>Push Button Switch Part No R13-527D2L-02 12V R13-527D2L-02 24V</p> <p>4P SPST (LED Independent) TERMINAL 0 2 .187" SQ</p>	 <p>Rocker Switch with light IP65 Rating DC 12V 16A Part Number R13-112B8-02 2pins ON-OFF</p>	 <p>Water/Dust Resistance Rocker Switch with light IP65 Rating DC 12V 16A Part Number R13-112B8-02 2pins ON-OFF</p>
 <p>PANEL (plate only without switch) Racing Finish Part Number R18-Q1A-R PLATE Wooden Finish Part Number R18-Q1A-W PLATE</p>	 <p>PANEL SWITCH 1 start / 1 Battery switch / 1 light Wooden Finish Part Number R18-S1A-W 12V PANEL SWITCH 1 start / 1 Battery switch / 3 switch / 1 light Wooden Finish Part Number R18-S3A-W 12V</p>	  <p>Rocker Switch to replace SWF switch (with light) 6P DPDT Part Number R13-289B-BBR28V (Red) R13-289B-BBG28V (Green) R13-289B-BBY28V (Yellow) 6P DPDT Part Number R13-289E-BBR 28V</p>

 <p>Rocker Switch DC 12V20A <u>Part Number</u> R13-91B (RED) R13-91B (GREEN) R13-91B (YELLOW) B ON OFF 3P SPST (ILLUMINATED)</p>	 <p>Water/Dust Resistance Rocker Switch with light IP65 Rating DC 12V 16A <u>Part Number</u> R13-238B8 12V ON-OFF</p>	 <p>Toggle Switch DC 12V 16A <u>Part Number</u> R13-238C 3pins ON-ON</p>
 <p>ROCKER (ON-ON) <u>Part Number</u> R13-282B1-01-BBNN</p>	 <p>ROCKER SWITCH (ON-OFF) <u>Part Number</u> R13-129A</p>	 <p>ROTARY SWITCH 4 POSITIONS <u>Part Number</u> R13-702C1 24V</p>
 <p>PR18-F2 ROCKER SWITCH PANEL FOR R13-289</p>	 <p>0986-348-618 SWITCH HOLDER</p>	 <p>DOOR SWITCH <u>Part Number</u> R13-918</p>
 <p>Push Pull Switch DC12V 10A <u>Part Number</u> GP1C (Button B + Enclosure B) GP 2C (Button B + Enclosure A) GP2D (Button A+ Enclosure A)</p> <p>Button A 25.5 Button B 13 Enclosure A 20.7mm Enclosure B 7.2mm 15.7 mm max 2.2 mm max</p>		 <p>PR18-R3A TOGGLE SWITCH PANEL</p>







USB Adapter

 <p>USB Adapter 12V/24V > 5V 2.1A <u>Part Number</u> A13-194BPS</p>	 <p>USB charger 12V/24V > 5V 2.5A <u>Part number</u> A13-203A</p>	 <p>Dual USB Adapter 12V/24V >5V 2A <u>Part Number</u> A13-164D</p>	 <p>USB charger 12V/24V > 5V 2.4A X 2 <u>Part number</u> 13-208</p>
---	---	---	--

D.C CONTACTOR

<p>Continuously ES-002C24V ES-002A 12V</p> 	<p>ES-206C 24V continuously</p> 	<p>ES-501A 12V continuously</p> 	<p>SW80-436P</p> 
--	---	---	--



OTHER SWITCHES/SENSOR

 <p>Thermo Switch Part No 30098-39300 Screw 30098-39400 30098-39400 NC 30098-39400 105°C 30098-39400 110NO 30098-39400 110NC</p>	<p>Description Screw, NO, 95°C NO 98°C NC 98°C NO 105°C NO 110°C NC110°C</p>	 <p>Oil Pressure Part No 4D4785 4D4785-3T S76072 15PSI S76074 60PSI S78152 15PSI</p>	<p>Switch Description 2 screw 4PSI 3 screw 10 PSI 3 screw 15 PSI 3 screw 60 PSI 1 screw NC 15 PSI</p>	<p>Oil Pressure Switch Part No: OS-03L</p> 	<p>Turn Signal Switch Part No: 083-865-010</p> 
<p>Brake Switch (oil) P/No: GS-E18</p> 	<p>Brake Switch (Oil) Part No: S25PK</p> 	<p>Head Light Switch Part No: EN722000</p> 			











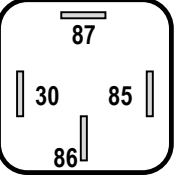

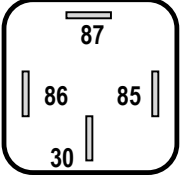
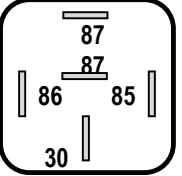
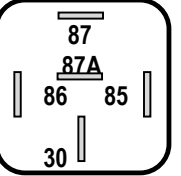
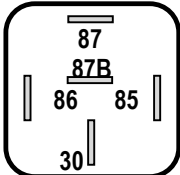
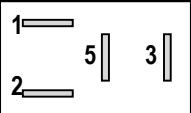

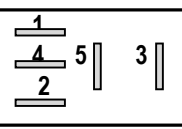
BATTERY SWITCH/RELAY

<p>083-856-001 12/24V 100A</p> 	<p>E108C</p> 	<p>E108 150A</p> 	<p>E108Z 20A</p> 	<p>E108M</p> 	<p>E108Y</p> 
<p>083-858-004 12/24V 250A Two pole Switch</p> 	<p>083-857-00312/24V 250A</p> 	<p>083-859-011 12/24V 600A</p> 	<p>7H7290</p> 	<p>Battery Selector Switch FBS-1601 selector switch 6-32V 250A</p> 	<p>Battery Switch Selector A23-3 12-50V 200AMP A23-2 12-50V 200amp</p> 
<p>Part No: BS2-082-2 24V 120A</p> 	<p>Part No: 0333-301-010 24V 250A</p> 	<p>Part No: 25510-00Z00 24V 100A</p> 	<p>Part No: BR253 24V 60A</p> 	<p>Part No: BR262 24V 30A</p> 	<p>1119865 w Bracket 12V</p> 

EMERGENCY/SAFETY RELAY







Part No: SN2111 12V 	Part No: 0-25000-5591 24V 	Part No: 0-25000-7283 24V 	Part No: R008T30175 24V 	P/No: 0590-001-1992 24V 	Part No: AST2-50 24V 
--	--	---	--	--	---

RELAY

 Part No Description R2142 12V 30A R2144 12V 40A 0332-019-453 12V 30A 	 P/ No Description R2242 12V 30A MG-1M 12V 30A R2270 12V 70A R2274 24V 40A R2275 24V 70A R2243 12V 30A w/fuse R4243 24V 20A w/fuse	 P/ No Description MG5-1M 12V 30A 0332-019-150 12V 30A R2254 12V 40A R4252 24V 20A 0332-019-203 24V 20A R4254 24V 30A	 Part No Description R905S 12V 12V 30A (waterproof with resistor) R2264 12V 70/40A R2265 12V 20/30A (diode) R4262 24V 10/20A 0986-AH0-613 24V 10/20A R905V24V 24V 30A/40A (waterproof) R4264 24V 40/30A R4265 24V 10/20A (diode) R4268 24V 20/30A
 P/ No Description 0332015008 24V 2x10A	 Part No Description RD1211 12V ACM33201 waterproof 	 P/ NoDescription RD1201 12V ACV11112 12V R706HV 24V 30A R1465 24V 10/15A (with resistor) 0332-207-405 24V 20/10A (with resistor)	 Part No Description 0332-002-150 12V 75A 0332-002-256diode 24V 50A 0332-002-257 24V 50A 0332-002-250 24V 50A 
 Glow Relay P/No: MR82C-752 24V 5 pins	 Part No MS2-1041-2 12V MS2-1002-2 24V	 Starting Relay P/No: 056700-5440 12V 4pins	 Heavy Duty Relay Part No P/No: 586-105111 12V P/No: 3050692 24V P/No: 586-117111 36V P/No: 586-120111 48V
 Heavy Duty Change over Relay Part No P/No: 586-314111 24V	 Continuous Relay Part No Description ARD1158 12V 80A ARD1137 12V 150A ARD1159 24V 80A ARD1138 24V 150A ARD1303 24V 300A	 Volt Part No 12V 12744 12V 12769 (silver) 24V 12745 24V 12770 (sliver) 36V 12746 48V NS24481A	 Relay Part No P/No: 3916301R 12V P/No: 3916302R 24V

 <p>Safety Relay P/No: 1599-001-0020</p>	 <p>Head Light Relay Part No: NLR132 12V</p>	 <p>Horn Relay Part No: HR212 12V Part No: HR213 24V</p>	 <p>Timer Relay Part No ATMR-2012 12V ATMR-2024 24V</p>
 <p>Heating Timing Relay P/No: A662-545-3532 12V</p>	 <p>Timer Relay P/No: 8-94416-583-0 12V</p>	 <p>Glow Relay Part No: R205-18-670 12V MR8B-042 24V</p>	 <p>Timer Glow Relay Part No: 8-97040-501-0 12V 6 pins</p>
 <p>Starter Relay (insulated) Part Number SS20-12V SS40-24V</p>	 <p>Relay Continuous (insulated) Part Number 860866-24V 860870-12V</p>	 <p>Relay intermittent (insulated) Part Number 860024-24V 12765 12V</p>	 <p>Relay intermittent (insulated) Part Number 0333-006-006 24V</p>

SOCKET FOR RELAY

 <p>Socket for 5pin relay Part No 3334-485-008 Bosch</p>	 <p>Socket for 4pin High Power relay Part No 2223</p>	 <p>Socket for 4pin High Power relay Part No W558</p>	 <p>Socket for 5pin High Power relay Part No W559</p>
 <p>Relay Holder for 5pin mini relay (RD1211) Part No 112305 Flosser</p>	 <p>Relay Holder 3334-485-008 and Fuse Holder 2211 combination kit</p>		

 <p>GCA-100 CIRCUIT BREAKER (WATERPROOF TYPE IP67)</p>	 <p>GCB-80 CIRCUIT BREAKER (WATERPROOF TYPE IP67)</p>
--	--

LIMIT SWITCH/WEIGHT/CABLE

<p>Limit Switch AssP/No:LIMITSW333</p> 	<p>Part No: LIMIT.SW CABLE</p> 	<p>Part No: LIMIT.SW WEIGHT</p> 	<p>Emergency Stop Switch 87943</p> 	<p>Emergency Stop Sw,Limit A22-E-RPV</p> 
<p>Part No: HW BZC-2RQ181-A2</p> 	<p>P/No: HW BZC-2RQ1-A2 Limit Sw</p> 	<p>Part No: LIMIT Z-15GD-B Limit Switch</p> 	<p>Part No: HW BZC-2RW822-A2</p> 	<p>Part No: HW BZC-2RW82-A2</p> 
<p>Part No: HW BZC-2RQ18-A2</p> 	<p>Part No: LIMIT Z-15G55-B</p> 	<p>Part No: LIMIT DPDT Limit Switch</p> 	<p>Part No: HW SL-H</p> 	<p>Part No: HW SL-A</p> 
<p>Part No: HW SZL-WL-A-A01AH</p> 	<p>P/No: LIMIT ZE-NA2-2 Limit Switch</p> 	<p>Part No: HW ZLDA01A2A</p> 	<p>Part No: HW SZL-WL-B-A01AH</p> 	<p>Part No: HW SZL-WL-K-A01H</p> 
<p>Part No: HW 91PCE16P1B</p> 	<p>Part No: HW BX4A3K-1A</p> 	<p>Part No: HW BZC-2R-A2</p> 	<p>Part No: HW BZC-2RD-A2</p> 	<p>Part No: HW BZC-2RW80-A2</p> 





<p>Part No: HW BZC-2RW82-A2</p> 	<p>Part No: HW BZC-2RW876T</p> 	<p>Part No: HW GXE51A1B</p> 	<p>Part No: HW GXE51B</p> 	<p>Part No: HW GXE51C</p> 
<p>Part No: HW HLS-B</p> 	<p>Part No: HW HLS-C</p> 	<p>Part No: HW JM1206ED1C2</p> 	<p>Part No: HW JM1210UD1C2</p> 	<p>Part No: HW JM1812ED1C2</p> 
<p>Part No: HW JM1820UD1C2</p> 	<p>Part No: HW JM3022ED1C2</p> 	<p>Part No: HW JM3040UD1C2</p> 	<p>Part No: HW JPA1705ED1C2</p> 	<p>Part No: HW JPA1708UD1C2</p> 
<p>Part No: HW JPA2508ED1C2</p> 	<p>Part No: HW JPA2510UD1C2</p> 	<p>Part No: HW JPA3010ED1C2</p> 	<p>Part No: HW JPA3015UD1C2</p> 	<p>Part No: HW JPA4015ED1C2</p> 
<p>Part No: HW JPA4020UD1C2</p> 	<p>Part No: HW JSM802ED1C2</p> 	<p>Part No: HW JSM804UD1C2</p> 	<p>Part No: HW SL-A1</p> 	<p>Part No: HW SL-B1</p> 

<p>Part No: HW SL-E</p> 	<p>Part No: HW SL-P</p> 	<p>Part No: HW SLP-A1</p> 	<p>Part No: HW SLP-E</p> 	<p>Part No: HW SLP-H</p> 
<p>Part No: HW SZL-VL-S-C</p> 	<p>Part No: HW SZL-VL-S-H</p> 	<p>Part No: HW SZL-VL-S-J</p> 	<p>Part No: HW SZL-WL-B-A01CH</p> 	<p>Part No: HW SZR-MY2-S-1A1</p> 
<p>Part No: HW SZR-MY2-S-1D24</p> 	<p>Part No: HW SZR-MY4-S-N1A2</p> 	<p>Part No: HW SZX-SMF-08SN</p> 	<p>Part No: HW SZX-SMF-14SN</p> 	<p>Part No: HW ZLDXA01A1B</p> 
<p>Part No: HW ZLDXA01A2B</p> 	<p>Part No: HW ZLDXA01A4J</p> 	<p>Part No: HW ZLDXA01B</p> 	<p>Part No: HW ZLDXA01C</p> 	<p>Part No: HW ZLDXA01D</p> 
<p>Part No: HW 1NT1-2-N</p> 	<p>Part No: HW 1NT1-7-N</p> 	<p>Part No: HW 1TL1-3-N</p> 	<p>Part No: HW 2TL1-50-N</p> 	

GLOW PLUG FOR ALL DIESEL ENGINE



WIPER BLADE

 <p>20 Series Heavy Duty Wiper Blades For Flat/Curved Windshields -For Trucks & Buses -Graphite Coating</p> <table border="0"> <tr> <td>Part Number</td> <td>Length</td> </tr> <tr> <td>WB-2028S*</td> <td>28"</td> </tr> <tr> <td>WB-2032S*</td> <td>32"</td> </tr> <tr> <td>WB-2036S*</td> <td>36"</td> </tr> <tr> <td>WB-2040S*</td> <td>40"</td> </tr> </table> <p>*Single pack</p>	Part Number	Length	WB-2028S*	28"	WB-2032S*	32"	WB-2036S*	36"	WB-2040S*	40"	 <p>21 Series Heavy Duty Wiper BladesFor Flat Windshields -For Trucks & Buses -Graphite Coating</p> <table border="0"> <tr> <td>Part Number</td> <td>Length</td> </tr> <tr> <td>WB-2118S*</td> <td>18"</td> </tr> <tr> <td>WB-2120S*</td> <td>20"</td> </tr> </table> <p>*Single Pack</p>	Part Number	Length	WB-2118S*	18"	WB-2120S*	20"	 <p>52 Series Universal Medium Duty Wiper Blades -Graphite Coating</p> <table border="0"> <tr> <td><u>Part Number</u></td> <td><u>Length</u></td> </tr> <tr> <td>WB-1014S*</td> <td>14"</td> </tr> <tr> <td>WB-5216**</td> <td>16"</td> </tr> <tr> <td>WB-5216S*</td> <td>16"</td> </tr> <tr> <td>WB-5216S/22S</td> <td>16" & 22"</td> </tr> <tr> <td></td> <td>(16" & 22" one each)</td> </tr> <tr> <td>WB-5216S/24S</td> <td>16" & 24"</td> </tr> <tr> <td></td> <td>(16" & 24" 1 each)</td> </tr> <tr> <td>WB-5217**</td> <td>17"</td> </tr> <tr> <td>WB-5217S*</td> <td>17"</td> </tr> <tr> <td>WB-5218**</td> <td>18"</td> </tr> <tr> <td>WB-5219**</td> <td>19"</td> </tr> <tr> <td>WB-5219S*</td> <td>19"</td> </tr> <tr> <td>WB-5220-8**</td> <td>20"</td> </tr> <tr> <td>WB-5221**</td> <td>21"</td> </tr> <tr> <td>WB-5221S*</td> <td>21"</td> </tr> <tr> <td>WB-5222**</td> <td>22"</td> </tr> <tr> <td>WB-5224S*</td> <td>24"</td> </tr> <tr> <td>WB-5226S*</td> <td>26"</td> </tr> </table> <p>*Single Pack ** Double Pack</p>	<u>Part Number</u>	<u>Length</u>	WB-1014S*	14"	WB-5216**	16"	WB-5216S*	16"	WB-5216S/22S	16" & 22"		(16" & 22" one each)	WB-5216S/24S	16" & 24"		(16" & 24" 1 each)	WB-5217**	17"	WB-5217S*	17"	WB-5218**	18"	WB-5219**	19"	WB-5219S*	19"	WB-5220-8**	20"	WB-5221**	21"	WB-5221S*	21"	WB-5222**	22"	WB-5224S*	24"	WB-5226S*	26"	 <p>70 Series Beam Blade (Flat Blade) OE Type, fit on new vehicles -Graphite Coating</p> <table border="0"> <tr> <td><u>Part Number</u></td> <td><u>Length</u></td> </tr> <tr> <td>WB-7126S*</td> <td>26"</td> </tr> <tr> <td>WB-7314SF*</td> <td>14"</td> </tr> <tr> <td>WB-7316SF*</td> <td>16"</td> </tr> <tr> <td>WB-7317SF*</td> <td>17"</td> </tr> <tr> <td>WB-7318SF*</td> <td>18"</td> </tr> <tr> <td>WB-7319SF*</td> <td>19"</td> </tr> <tr> <td>WB-7320SF*</td> <td>20"</td> </tr> <tr> <td>WB-7322SF*</td> <td>22"</td> </tr> <tr> <td>WB-7324SF*</td> <td>24"</td> </tr> </table> <p>*Single Pack</p>	<u>Part Number</u>	<u>Length</u>	WB-7126S*	26"	WB-7314SF*	14"	WB-7316SF*	16"	WB-7317SF*	17"	WB-7318SF*	18"	WB-7319SF*	19"	WB-7320SF*	20"	WB-7322SF*	22"	WB-7324SF*	24"
Part Number	Length																																																																												
WB-2028S*	28"																																																																												
WB-2032S*	32"																																																																												
WB-2036S*	36"																																																																												
WB-2040S*	40"																																																																												
Part Number	Length																																																																												
WB-2118S*	18"																																																																												
WB-2120S*	20"																																																																												
<u>Part Number</u>	<u>Length</u>																																																																												
WB-1014S*	14"																																																																												
WB-5216**	16"																																																																												
WB-5216S*	16"																																																																												
WB-5216S/22S	16" & 22"																																																																												
	(16" & 22" one each)																																																																												
WB-5216S/24S	16" & 24"																																																																												
	(16" & 24" 1 each)																																																																												
WB-5217**	17"																																																																												
WB-5217S*	17"																																																																												
WB-5218**	18"																																																																												
WB-5219**	19"																																																																												
WB-5219S*	19"																																																																												
WB-5220-8**	20"																																																																												
WB-5221**	21"																																																																												
WB-5221S*	21"																																																																												
WB-5222**	22"																																																																												
WB-5224S*	24"																																																																												
WB-5226S*	26"																																																																												
<u>Part Number</u>	<u>Length</u>																																																																												
WB-7126S*	26"																																																																												
WB-7314SF*	14"																																																																												
WB-7316SF*	16"																																																																												
WB-7317SF*	17"																																																																												
WB-7318SF*	18"																																																																												
WB-7319SF*	19"																																																																												
WB-7320SF*	20"																																																																												
WB-7322SF*	22"																																																																												
WB-7324SF*	24"																																																																												

HORN

 <p>Denso Horn 12V 111DB <u>Part Number</u> Horn ND 12V 6930 Set</p>	 <p>Flosser Horn Diameter 82mm</p> <table border="0"> <tr> <td><u>Part Number</u></td> <td></td> </tr> <tr> <td>Horn 129306</td> <td>12V</td> </tr> <tr> <td>Horn 241446</td> <td>24V</td> </tr> </table>	<u>Part Number</u>		Horn 129306	12V	Horn 241446	24V	 <p>Flosser Horn Diameter 100mm <u>Part Number</u> Horn 244508 24B H pc Horn 247858 24V set Horn 124508 12V H pc</p>
<u>Part Number</u>								
Horn 129306	12V							
Horn 241446	24V							

	<p>Nikko Horn Diameter 90 mm 24V 108DB Available in pair & single piece (high tone) <u>Part Number</u> Horn CF4D-24V-set Horn CF4HH-24V-pc</p>		<p>Nikko Horn Diameter 115mm 24V 115 DB Available in pair & single piece (high tone) <u>Part Number</u> Horn KFD115-24V R-set Horn KF115-24V (H) – pc</p>		<p>Nikko Horn Diameter 85 mm 12V 108 DB Available in sets <u>Part Number</u> HORN YFD85-12V R set</p>
	<p>Denso Horn Diameter 85mm 105DB 12V & 24V Available in pair <u>Part Number</u> Horn ND 12V 5100 set Horn ND 24V 5300set</p>		<p>Denso Horn Diameter 72mm 111DB 12V Available in pair <u>Part Number</u> HORN ND 12V 6920</p>		<p>Back Up Buzzer (Intermittent) 12-24V 90-100 DB <u>Part Number</u> Horn EBS-12/24V</p>
	<p>Back Up Buzzer (Continuous) 12-24V 90-100 DB <u>Part Number</u> Horn EBC-12/24V</p>		<p>Buzzer (Intermittent) 12-24V <u>Part Number</u> Horn EBL-12/24V</p>		<p>Siren 12V & 24V <u>Part Number</u> HORN SM30 12V HORN SM30 24V</p>
	<p>Nikko Horn 48V 105DB Available in single piece (high tone) <u>Part Number</u> HORN SPH-48V</p>		<p>Loud Back Up Buzzer 12-36V 112DB <u>Part Number</u> Horn 213-9100 (R) Horn 213-9200 (R)</p>		<p>Back-up Buzzer (Intermittent) 12-24V 107DB <u>Part Number</u> Horn EBR-12/24V</p>
	<p>Super Guard Alarm DC 1.5V x 4 <u>Part Number</u> Horn SG108</p>		<p>Buzzer 48V <u>Part Number</u> HORN B-021</p>		<p>Air Horn <u>Part Number</u> HORN 10102506 12V HORN 10102516 24V</p>
	<p>Alarm Buzzer for crane 12/24V <u>Part Number</u> HORN 29102.10</p>		<p>Alarm Bell 24V <u>Part Number</u> HORN BELL ALARM</p>		<p>2 Tone alarm 12/24V <u>Part Number</u> HORN EBT-12/24V</p>

TRANSFER SWITCH

AUTOMATIC TRANSFER SWITCH KT-ATS-100A-4PH 100A KT-ATS-225A-4PH 225A



TRANSFER SWITCH KT-ATS-100A-4PH 100A



AUTOMATIC TRANSFER SWITCH KT-ATS3PC0125-22



AUTOMATIC VOLTAGE REGULATOR AVR (FOR GENERATOR)

AVR-AEC42-7 Basler Electric



AVR-AVC63-25S Basler Electric



AVR-AVC63-7 Basler

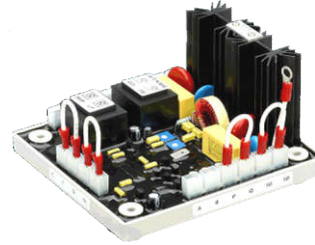

AVR-VR04C Basler Electric

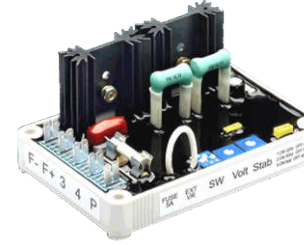

AVR-VC63-4A Basler Electric



NTA-5A-2T LO MD Denyo Max180KVA



NTA-5A-2T HI MD Denyo

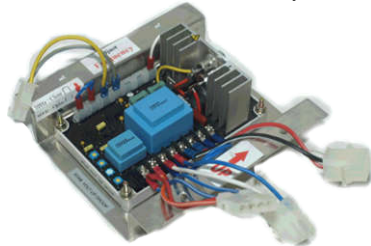

AN-5-203 MD Denyo

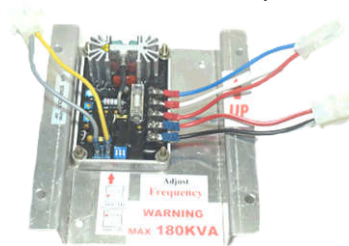

AVR-ND35 Denyo 280



AVR-C255670 Kohler

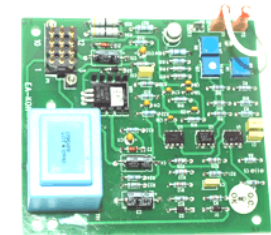

AVR-R230 Leroy Somer



AVR-R448 / R438 Leroy Somer



AVR-SE350 Marathon





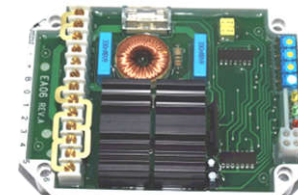





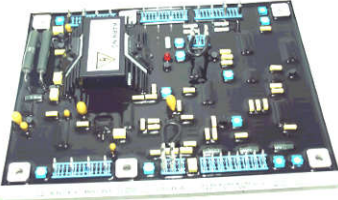



AVR-UVR6 Mecc Alte



AVR-SR7 for Mecc Alte



<p>AVR-MX321 Newage/Stamford/Onan</p> 	<p>AVR-MX341 Newage/Stamford/Onan</p> 	<p>AVR-SX440 Newage/Stamford/Onan</p> 	<p>AVR-SX460 Newage/Stamford/Onan</p> 	<p>NVR-401A Nissha</p> 
<p>AVR-EW05 Welder</p> 	<p>AVR-RS29038B04 small generator Yanmar</p> 	<p>AVR-EB500 Auto Flashing</p> 	<p>AVR-ADVR-053 Digital hybrid AVR</p> 	<p>AVR-ADVR-073 Digital hybrid AVR</p> 
<p>AVR-AVC63-7 for Basler AVR</p> 	<p>AVR-VR63-4A for Basler AVR</p> 	<p>AVR-ADVR-12 Digital hybrid AVR for caterpillar</p> 	<p>AVR-ADVR-16 Digital hybrid AVR</p> 	

OTHER GENERATOR PARTS

<p>KT-CH3512 / 24 Battery Charger with float function for Generator</p> 	<p>KT-DSP-10 Multi Function Display Genset Display Unit</p> 	<p>KT-ECU-02 Engine Control Unit</p> 	<p>KT-ECU-04-12V/24V Auto-Start Control Board With Pre-Heat, Diesel/Petrol Engine</p> 	<p>KT-ECU-05-12V/24V Auto-Start Control Board Diesel Engine</p> 
---	---	---	---	---













<p>KT-ECU-22 Control Relay 24v For ECU-02</p> 	<p>KT-EG2000 KT-EG2000R Engine Control Normal Type</p> 	<p>KT-DSP-52 CAN BUS J1939 READER</p> 	<p>KT-GCU-10 Generator Control Unit</p> 	<p>KT-GCU-100 Digital Generator Control Unit With Protection Module</p> 
<p>KT-GCU-11R-24V Relay Module</p> 	<p>KT-GCU-20 Engine Control Unit Use with sensor</p> 	<p>KT-GCU-2000 Advanced Digital Generator PLC Control Unit</p> 	<p>KT-GCU-30 Generator Control Unit with Key Control</p> 	<p>KT-L250HS3P-24V High Breaking Current with 24V Trip Coil KT-L250HS3P-220V</p> 
<p>KT-PTU-03 Isolation Transformer</p> 	<p>KT-SHT225 220V Trip Coi KT-SHT225 12/24V</p> 	<p>Trip Coil: KT-SHT400 220V, KT-SHT400 12/24V</p> 	<p>KT-U400HS3P-24V High Breaking Current with 24V Trip Coil and AUX KT-U400HS3P-220V</p> 	<p>ELECTRONIC SPEED SWTICH ECU-SS40</p> 
<p>GOVERNOR CONTROLLER 12/24V KT-EG4015</p> 				

WARNING LIGHT

 <p>Beacon (Rotary) Available in 12V & 24V Blue, Red, Amber Dia 153mm, Height 165mm <u>Part Number</u> SP 320-00 (Amber) SP 320-01 (Blue) SP 320-02 (Red)</p>	 <p>Beacon (Rotary) Magnetic Available in 12V & 24V Available in Red & Amber Dia 155mm, Height 169mm <u>Part Number</u> SP 324-00 DV (Amber)</p>	 <p>Beacon (Rotary) 12V & 24V, Blue, Red, Amber Dia 153mm, Height 188mm <u>Part Number</u> SP 370-00 (Amber) SP 370-01 (Blue) SP 370-02 (Red)</p>
 <p>Beacon (Rotary) Screw Available in 12V & 24V Available in Amber Dia 149mm, Height 215mm <u>Part Number</u> SP 371-00 (Amber)</p>	 <p>Beacon (Rotary) Plug-In Available in 12V & 24V Available in Amber Dia 149mm, Height 245mm <u>Part Number</u> SP 372-00 (Amber)</p>	 <p>Beacon (Rotary) Magnetic Available in 12V & 24V Available in Amber Dia 155mm, Height 191mm <u>Part Number</u> SP 374-14 (Amber)</p>
 <p>Beacon (Rotary) Available in 12V & 24V Available in Amber Dia 153mm, Height 197mm <u>Part Number</u> SP 390-00</p>	 <p>Beacon Rotary Light Screw 24V Dia 84mm Height 133mm <u>Part Number</u> SP S80U-24-Y 24V</p>	 <p>Beacon Rotary Screw 24V Dia 119 mm Height 164mm <u>Part Number</u> SP S125E-24-Y 24V</p>
 <p>Beacon Rotary Magnetic 24V Dia 119mm Height 156mm <u>Part Number</u> SP S125M-24-Y 24V</p>	 <p>Light Bar 24V2 module rotating Length 420mm, Height 130mm, Width 205mm <u>Part Number</u> SP A421-00-24V</p>	 <p>LED Light Bar 12/24V Length 750mm, Height 165mm, Depth 200mm <u>Part Number</u> SP A6612-00 LDV</p>
 <p>LED Light Bar 12/24V Length 520mm, Height 165mm, Depth 200mm <u>Part Number</u> SP A6602-00 LDV</p>	 <p>Double Flash (Xenon) Beacon Voltage: 10-30V Available in Amber Dia 153mm, Height 188mm <u>Part Number</u> SP 270-00 DV</p>	 <p>Double Flash (Xenon) Magnetic Beacon Voltage: 10-30V Available in Amber Dia 155mm, Height 191mm <u>Part Number</u> SP 274-00 DV</p>
 <p>Beacon (Xenon) Dual Voltage: 12V-24V Amber, Red 125 Flash/min Dia 153mm, Height 179mm <u>Part Number</u> SP B290-00 DV (Amber)</p>	 <p>Beacon (Xenon) Magnetic Dual Voltage: 12V-24V Available in Amber Dia 155mm, Height 182mm <u>Part Number</u> SP B294-00 DV (Amber)</p>	 <p>Beacon (Xenon) Voltage: 10V-100V Available in Amber, Red Dia 154, Height 121mm <u>Part Number</u> SP B10-00 MV (Amber) SP B10-01 MV (Blue) SP B10-02 MV (Red)</p>

 <p>Beacon (Xenon)Magnetic Voltage: 10V-100V Available in Amber Dia 156, Height 121mm</p> <p><u>Part Number</u> SP B14-00 MV (Amber)</p>	 <p>Beacon (LED) Voltage: 10V-49V Available in Amber, Dia 154, Height 121mm</p> <p><u>Part Number</u> SP B60-00 LMV (Amber)</p>	 <p>Beacon (LED) Voltage: 10V-49V Available in Amber, Magnetic Base</p> <p><u>Part Number</u> SP B64-00 LMV (Amber)</p>
 <p>Beacon (LED) Voltage: 10V-49V Available in Amber Dia 148, Height 285mm</p> <p><u>Part Number</u> SP B95-00 LMV (Amber)</p>	 <p>Beacon (LED) Voltage: 10V-30V Available in Amber Dia 130mm, Height 52mm R65 EMC certified, IP65 10 flash patterns</p> <p><u>Part Number</u> SP B350-00 LDV (Amber)</p>	 <p>Beacon (LED) Voltage: 10V-49V Available in Amber Dia 154, Height 188mm EMC10.03</p> <p><u>Part Number</u> SP B70-00 LDV (Amber)</p>
 <p>Airport Beacon Light Available in 12V & 24V Dia 153mm, Height 165mm 3 screws base Certified for airport use</p> <p><u>Part Number</u> SP B330-00 12V SP B330-00 24V</p>	 <p>Airport Beacon Light Magnetic Available in 12V & 24V Dia 153mm, Height 165mm Single screw base Certified for airport use</p> <p><u>Part Number</u> SP B331-00 12V SP B331-00 24V</p>	 <p>Airport Beacon Light Magnetic Available in 12V & 24V Dia 153mm, Height 165mm Magnetic base Certified for airport use</p> <p><u>Part Number</u> SP B334-00 12V SP B334-00 24V</p>
 <p>Beacon (LED) Voltage: 10V-30V Available in Amber Dia 154, Height 126mm R65 EMC certified</p> <p><u>Part Number</u> SP B320-00 LDV (Amber)</p>	 <p>Beacon (LED) Voltage: 10V-30V Available in Amber Dia 130mm, Height 140mm R65 EMC certified, IP67</p> <p><u>Part Number</u> SP B310-00 LDV (Amber)</p>	 <p>Beacon (LED) Voltage: 10V-80V Available in Amber R65 EMC certified, IP67</p> <p><u>Part Number</u> SP LED-VB591Y MV</p>
 <p>Beacon (LED) 10-110V 20 LEDs Dia. 104mm, Height 94mm</p> <p><u>Part Number</u> SP LED-SB550B MV (Blue) SP LED-SB550R MV (Red) SP LED-SB550Y MV (Amber)</p>	 <p>LED Triple Flash Strobe Light 10-110VDC 30LEDs 130mmx98mmx112mm</p> <p><u>Part Number</u> SP LED-SB230B MV (Blue) SP LED-SB230R MV (Red) SP LED-SB230Y MV (Amber)</p>	 <p>LED Triple Flash Strobe Light Screw Base 10V-30V 15LEDs Amber Base.98mm, Height 112mm</p> <p><u>Part Number</u> SP LED-VB230Y DV (Amber)</p>









	<p>Beacon (LED) 12/24V 80 LEDs</p> <p><u>Part Number</u> SP LED-SB731Y DV (Amber)</p>		<p>Beacon (LED) 12/24V 60 LEDs</p> <p><u>Part Number</u> SP LED-SB780Y DV (Amber)</p>		<p>Beacon (LED) 12/24V 12 LEDs 18W Height 120mm Base 148mm 3 bolt <u>Part Number</u> SP DB5001A DV</p>
	<p>Beacon (LED) 12/24V 12 LEDs 18W Height 120mm Base 148mm 1 bolt <u>Part Number</u> SP DB5002A DV</p>		<p>Beacon (LED) 12/24V 12 LEDs 18W Height 120mm Base 148mm Magnetic Mount <u>Part Number</u> SP DB5004A DV</p>		<p>LED Strobe Light Screw Base 10V-30V 60LEDs <i>Dia.120mm, Height 122mm</i></p> <p><u>Part Number</u> SP LED-VB621R DV (Red) SP LED-VB691Y MV (Amber)</p>
	<p>LED Strobe Light Screw Base 12V-24V 90LEDs <i>Dia. 120mm, Height 207mm</i></p> <p><u>Part Number</u> SP LED-58VB-1 DV (Blue)</p>		<p>LED Strobe Light Magnetic Base 10V-30V 60LEDs <i>Dia.120mm, Height 122mm</i></p> <p><u>Part Number</u> SP LED-VB694Y DV (Amber)</p>		<p>LED SolarCell Light Screw Flashing & Non Flashing <i>Dia. 100mm</i></p> <p><u>Part Number</u> SP LED-S100*CON*C (Clear) SP LED-S100*CON*R (Red) SP LED-S100*CON*Y (Amber)</p>
	<p>Battery operated LED Beacon 4XAA 6V Battery <u>Part Number</u> SP LED-VB884B 6V (Blue) SP LED-VB884R 6V (Red) SP LED-VB884Y 6V (Amber)</p>		<p>Light (Non-Flashing) 24V (able to change the bulb to LED bulb) <i>Dia. 82mm, Height 125mm</i></p> <p><u>Part Number</u> SP PS-24-R</p>		<p>Tower Warning Light LED Strobe 24V <i>Width 90, Height 351mm</i></p> <p><u>Part Number</u> SP SJL3-24-RAG</p>
	<p>Tower Warning Light with Alarm (Rotary) 24V <i>Dia 90mm, Height 448mm</i></p> <p><u>Part Number</u> SP SJD3-24-RAG</p>		<p>Tower Warning Light (Rotary) 24V <i>Dia 80mm, Height 348mm</i></p> <p><u>Part Number</u> SP SR3-24V</p>		<p>Tower Warning Light (Rotary) 24V <i>Width 90mm, Height 351mm</i></p> <p><u>Part Number</u> SP SJ3-24V</p>
	<p>Tower Warning Light (Rotary) 24V <i>Width 125mm, Height 380mm</i></p> <p><u>Part Number</u> SP KJ-302-RYG</p>		<p>High Power LED Strobe Light 10-30V <u>Part Number</u> SP LED-VB18VB DV (Blue) SP LED-VB18VR DV (Red) SP LED-VB18VW DV (White) SP LED-VB18VY DV (Amber)</p>		<p>LED Rectangle Strobe Light 12V Blue Colour <i>186mmx95mm</i></p> <p><u>Part Number</u> SP LED-L45B-12</p>

 <p>Emergency Light (Breakdown Signal Lamp) 3V <i>Dia 38mm, Height 150mm</i> <u>Part Number</u> SB ESL-100</p>	 <p>LED Slave Strobes Light 12-24V 4 High Power LEDs <i>50mmx123mm x 31 mm</i> <u>Part Number</u> SP LED-VB04Y DV(Amber) SP LED-VB04B DV (Blue) SP LED-VB04R DV (Red) SP LED-VB04W DV (White)</p>	 <p>LED R65 Approved Strobes Light 12-24V 3 High Power LEDs <i>46mm x 116mm x 23mm</i> 12 Flash patterns Waterproof IP67 EMC 10.03 <u>Part Number</u> SP L55-10 DV (Amber)</p>
 <p>LED R65 Approved Strobes Light Small and Bright 12-24V 8 High Power LEDs 23 Flash patterns Waterproof <u>Part Number</u> SP L94-00 DV (Amber) SP L94-01 DV (Blue)</p>	 <p>LED R65 Approved Strobes Light 12-24V 8 High Power LEDs <i>50mm x 99.7mm x 16.3 mm</i> 23 Flash patterns Waterproof <u>Part Number</u> SP L95-00 DV (Amber)</p>	 <p>LED R65 Approved Strobes Light 12-24V 4 High Power LEDs <i>31.5mm x 98.7mm x 18.3mm</i> 23 Flash patterns Waterproof <u>Part Number</u> SP L96-00 DV (Amber) SP L96-01 DV (Blue)</p>
<p>SP LED-VB351Y DV BEACON LIGHT BAR (YELLOW) (56X3W) <i>1170x193x76mm</i></p> 	<p>Beacon Light Bar 870x94x36mm 56 LED</p>  <p>SP LED-VLB72Y-12V(Yellow12V) SP LED-VLB72Y-24V(Yellow24V)</p>	<p>Beacon Light Bar 1140x94x36mm 72 LED</p>  <p>LED-VLB73BR-12 (blue/red12V) LED-VLB73R-12V (red12V) LED-VLB73Y-12 (yellow 12V) LED-VLB73Y-24V (yellow 12V)</p>
<p>Magnetic Light Bar 248x172x50mm 56 LED SP A514.00 LDV</p> 	<p>SP LED-ARROW-16 LED ARROW LIGHT 5.6A 12-24VDC</p> 	<p>SP LED-SAL-15 DV LED ARROW LIGHT</p> 





INTERIOR LAMP

	<p>Interior Roof Lamp 24V <i>Dia, 163mm, Height 44mm</i> <u>Part Number</u> SP AE-00-096 24V</p>
--	---

LED INTERIOR LAMP

	<p>LED Interior Light 9-30 VDC 75mm X 16mm <u>Part Number</u> SP AE-00-101 LED</p>		<p>LED Day Light Frosted Lens 12-35V 580mm 96 LED <u>Part Number</u> SB VCL-602W DV</p>		<p>12V & 24V, 60LEDs 202x131x34mm <u>Part Number</u> SP LED-VIL211-12V SP LED-VIL211-24V SP LED-VIL211W DV</p>
	<p>130mm X 20mm <u>Part Number</u> SP AE-00-1101 12V SP AE-00-1102 24V</p>		<p>LED Interior Light 12/24V, with on/off switch IP65 rated EMC10.04 <u>Part Number</u> SP L900-210 450mm 1130 lumens</p>		<p>12-30V 42LEDs 185mm <u>Part Number</u> SP LED-VIL121SW (with switch) SP LED-VIL131SW (without switch)</p>
	<p>10-30V <u>Part Number</u> SP LED-VIL238W DV</p>		<p>10-30V <u>Part Number</u> SP LED-VIL239W DV</p>		<p>12-30V 138LEDS 473MM <u>Part Number</u> SP LED-VIL121XLW (with switch) SP LED-VIL131XLW (without switch)</p>

HAND LAMP

	<p>12V & 24V <u>Part Number</u> SP LAM-001 12V SP LAM-001 24V</p>		<p>Universal plug fit to cigarette lighter, H3 Bulb 130mm x 89mm x 229mm <u>Part Number</u> SP NS-001B H3 12V SP NS-001B-C H3 24V</p>		<p>240VAC <u>Part Number</u> SP C2-121 240VAC</p>
	<p>12V 30pcs LED <u>Part Number</u> SP C2-88 12VDC</p>				

LICENSE PLATE LAMP

	<p>LED Number Plate Light 12/24V <u>Part Number</u> SP LED-VL148W DW</p>		<p>24V <u>Part Number</u> SP AE-05-512</p>		<p>24V <u>Part Number</u> SP AE-05-508</p>
--	--	--	---	---	---

STOP/TAIL/SIGNAL LAMP

 <p>Tail Lamp 24V (Left side) 324mmx196mmx130mm Part Number SP AE-04-416L</p>	 <p>Tail Lamp 24V (Right Side) 324mmx196mmx130mm Part Number SP AE-04-416R</p>	 <p>Tail Lamp 24V 224mmx57mmx50mm Part Number SP AE-04-454</p>
 <p>Tail Lamp 24V (Left side) 315mmx187mmx80mm Part Number SP AE-04-453L</p>	 <p>Tail Lamp 24V (Right side) 315mmx187mmx80mm Part Number SP AE-04-453R</p>	 <p>Tail Lamp 24V (Right side) 300mmx137mmx100mm Part Number SP Fuso Lamp/R</p>
 <p>Tail Lamp 12V Part Number SP F/L 0207LH</p>	 <p>Tail Lamp 12V Part Number SP F/L 0207RH</p>	 <p>Brake Signal Lamp Part Number SP F/L 15-1041</p>
 <p>Tail Lamp 24V Part Number SP AE-04-428M 24V</p>	 <p>Tail Lamp 24V Part Number SP AE-04-430L</p>	 <p>Tail Lamp 24V Part Number SP AE-04-430R</p>
 <p>Tail Lamp Part Number SP AE-04-437L</p>	 <p>Tail Lamp Part Number SP AE-04-437R</p>	 <p>Tail Lamp 24V Part Number SP AE-04-438B/L</p>
 <p>Tail Lamp 24V Part Number SP AE-04-438B/R</p>	 <p>Tail Lamp Part Number SP AE-04-440L</p>	 <p>Tail Lamp Part Number SP AE-04-440R</p>
 <p>Tail Lamp Part Number SP AE-04-443L</p>	 <p>Tail Lamp Part Number SP AE-04-443R</p>	 <p>Tail Lamp 24V (Left side) 300mmx137mmx100mm Part Number SP Fuso Lamp/L</p>
 <p>LED Stop/Tail Light 10V-30V 64LEDs 125mm x 125mm Part Number SP LED-VL95R DV (Red) SP LED-VL95W DV (White)</p>	 <p>LED Stop/Tail/Signal Light 24V Dia 140mm, thickness 82mm Part Number SP LED-VL168RY</p>	 <p>LED Signal Light 60LEDs 12V & 24V 176mm Amber Part Number SP LED-L08Y-12V (12V) SP LED-L08Y-24V (24V)</p>

 <p>LED Stop/Tail Light 12V-24V 40 LEDs Red, White & Amber Dia. 108.9mm x 53mm <u>Part Number</u> SP LED-VL3W DV (White) SP LED-VL3Y DV (Amber)</p>	 <p>LED Stop/Tail Light 60 LEDs 12V & 24V 176mm Red <u>Part Number</u> SP LED-L08R-12V (12V) SP LED-L08R-24V (24V)</p>	 <p>Led Indicator Light 10-30V <u>Part Number</u> SP LED-VL26HVY DV</p>
 <p>LED Signal Light 13LEDs 24V Amber <u>Part Number</u> SP NS-2805EL 24V</p>	 <p>LED Stop/Tail Light 13 LEDs 24V <u>Part Number</u> SP NS-2302S SAE-Compliant SP NS-2306EL ECE-Compliant</p>	 <p>Reverse Light 24V <u>Part Number</u> SP NS-2603E</p>
 <p>LED Tail Light 10-30V, Red & Amber Dia 52.1, Thickness 18mm <u>Part Number</u> SP LED-L13VR-1 DV (Red) SP LED-L13VY-1 DV (Amber)</p>	 <p>Signal Lamp Available in Red, Amber & White 24V Dia 78.6mm, Height 52mm <u>Part Number</u> SP AE-01-116W (white) SP AE-01-116R (red) SP AE-01-116Y (amber)</p>	 <p>LED Signal Light 24V 5LEDs 101.1mmx51.05mmx23.8mm <u>Part Number</u> SP LED-VL02Y-24V</p>
 <p>Arrow Signal Light 10-30V 45 Leds Amber <u>Part Number</u> SP LED-SH-10088 DV</p>	 <p>Signal Lamp (Square) Amber 24V Width 89mm, Height 100mm <u>Part Number</u> SP AE-03-328</p>	 <p>Signal Lamp (Dome) Amber 24V Dia 122mm, Height 153 5mm, Thickness 72mm <u>Part Number</u> SP AE-03-323-02</p>
 <p>LED Signal Light 18LEDs 24V Dia 123mm Amber ECE-Compliant <u>Part Number</u> SP NS-2823LED-24V</p>	 <p>LED Stop/Tail Light 18LEDs 24V Dia 123mm Red ECE-Compliant <u>Part Number</u> SP NS-2327LED-24V</p>	 <p>Reverse Light 18LEDs 24V Dia 123mm Clear ECE-Compliant <u>Part Number</u> SP NS-2605LED-12V</p>
 <p>LED indicator light 19LEDs 12V - 24V Dia 80mm x H 70mm <u>Part Number</u> SP LED-VL120G (Green) SP LED-VL120R (Red) SP LED-VL120W (Clear) SP LED-VL120Y (Amber)</p>	 <p>Marker Lamp 24V Height 81mm, Width 95 mm, Thickness 76 mm <u>Part Number</u> SP AE-01-168 24V</p>	 <p>LED Side Marker Light 10-30V 6LEDs 90mmx33mm <u>Part Number</u> SP LED-VL98R DV (Red) SP LED-VL98Y DV (Amber) SP LED-VL98W DV (White)</p>

 <p>LED Stop/Tail/Signal/Reverse Light 13LEDs each 12/24V ECE-Compliant</p> <p><u>Part Number</u> SP LED-VL306BV DV</p>	 <p>LED indicator light 19LEDs 12V - 24V Dia 63mm x H 30mm ECE-Compliant</p> <p><u>Part Number</u> SP AE-01-191 LED (Red)</p>	 <p>LED Reflector indicator light 12LEDs 12V - 24V Dia 63mm x H 30mm</p> <p><u>Part Number</u> SP AE-30-071 LED</p>
 <p>LED Marker Light 12V-33V 144MM X 44MM X 12MM</p> <p><u>Part Number</u> SP AE-01-258R LED</p>	 <p>LED Marker Light 12V-33V 144MM X 44MM X 12MM</p> <p><u>Part Number</u> SP AE-01-258W LED</p>	 <p>LED Marker Light 12V-33V 144MM X 44MM X 12MM</p> <p><u>Part Number</u> SP AE-01-258Y LED</p>
 <p>LED Marker Light for Boat 12V-30VDC</p> <p><u>Part Number</u> SP C2-128GLD-W1 225D SP C2-128GLD-W2 135D</p>	 <p>LED Marker Light for Boat 12V-30VDC</p> <p><u>Part Number</u> SP C2-128GLG-G1 112.5D</p>	
 <p>REVERSE LAMP 24V (left) Dia. 119mm, Length 142mm</p> <p><u>Part Number</u> SP NBUL-24L 24V Left SP NBUL-24R 24V Right</p>	 <p>LED Marker Light 12V-24V</p> <p><u>Part Number</u> SP LED-01-08R DV (red) SP LED-01-08W DV(white) SP LED-01-08YDV(Amber)</p>	 <p>LED Marker Light 24V 9 LEDs Amber 170mmx59mm</p> <p><u>Part Number</u> SP LED-VL101Y-24V</p>
 <p>SP AE-01-191 LED LED MARKER LAMP (RED) (3PCS LED)</p>	 <p>SP AE-01-258R LED LED SIDE MARKER 9-33V (RED)</p>	 <p>SP AE-01-258W LED LED SIDE MARKER (CLEAR)</p>
 <p>SP AE-01-258Y LED LED SIDE MARKER (AMBER)</p>	 <p>SP AE-04-541 (A) LED REAR LAMP (AMBER) 95MM</p>	 <p>SP AE-04-541 (C) LED REAR LAMP (CLEAR) 95MM</p>

 <p>SP AE-04-541 (R) LED REAR LAMP (RED) 95MM</p>	 <p>Backup Lamp 24V Dia. 99.5mm, Height115.5mm</p> <p>Part Number SP AE-06-605 24V</p>	 <p>Backup Lamp 24V Dia. 128mm, Height167mm</p> <p>Part Number SP AE-06-609 24V</p>
 <p><u>LED LIGHT</u> 24V 22mm hole</p> <p>Part Number AD56-22DS 24V</p>	 <p><u>LED LIGHT FLASHING</u> 24V 22mm hole flashing</p> <p>Part Number AD56-22SY 24V</p>	 <p><u>BUZZER W/LIGHT</u> 12V 22mm hole</p> <p>Part Number AD56-22SM 12V</p>
 <p><u>PANEL LED INDICATOR LIGHT</u></p> <p>Part Number R9-125LA6-11-RAG</p>	 <p><u>INDICATOR LED LAMP YELLOW</u> 24V</p> <p>Part Number R9-114L2</p>	 <p><u>PILOT LAMP</u> 12V</p> <p>Part Number R9-72B-G-12V</p>
 <p><u>PILOT LAMP</u> 12V</p> <p>Part Number R9-72B-Y-12V</p>	 <p><u>INDICATOR LED LAMP YELLOW</u> 24V</p> <p>Part number R9-92L</p>	 <p><u>INDICATOR LED LAMP YELLOW</u> 24V 16mm hole</p> <p>Part Number R9-105L</p>

WORKING LAMP

 <p>12V or 24V Dia150mm, Height185mm</p> <p>Part Number SP 1M1882 24V</p>	 <p>24V Width 128mm, Height170mm</p> <p>Part Number SP AE-06-615 24V</p>	 <p>H3 24V bulb Width152mm, Height 131mm</p> <p>Part Number SP AE-06-623 H3 (Flood) SP AE-06-624 H3 (Spot)</p>
--	--	--

 <p>H3 24V bulb Width 112mm, Height 150mm</p> <p><u>Part Number</u> SP AE-06-627 H3</p>	 <p>H3 24V bulb Width 128mm, Height 170mm</p> <p><u>Part Number</u> SP AE-06-631 H3</p>	 <p>Use H3 24V bulb Dia. 90mm</p> <p><u>Part Number</u> SP NS-101B-C H3 (Spot)</p>
 <p>Use H3 12V/24V bulb Dia. 115.8mm, Height 134mm</p> <p><u>Part Number</u> SP NS-103DC H3 (Spot) SP NS-103F-C H3 (Flood)</p>	 <p>Use H3 12V/24V bulb Dia. 115.8mm, Height 134mm</p> <p><u>Part Number</u> SP NS-103D-Y H3 (Yellow Lens)</p>	 <p>HID Xenon 24V</p> <p>Width 134mm, Height 185mm, Length 231mm</p> <p><u>Part Number</u> SP NS-1110F HID (Flood)</p>
 <p>Use H3 24V bulb Width 156mm, Height 94mm</p> <p><u>Part Number</u> SP NS-1111F H3 (Flood) SP NS-1111S H3 (Spot)</p>	 <p>24V using H3 Bulb Width 147mm, Height 203mm</p> <p><u>Part Number</u> SP NS-1112F H3 (Flood)</p>	 <p>Use H3 24V bulb Width 92mm, Height 111mm</p> <p><u>Part Number</u> SP NS-1113F H3 (Flood) SP NS-1113S H3 (Spot)</p>
 <p>Use H3 24V bulb Width 158.5mm, Height 176.2mm</p> <p><u>Part Number</u> SP NS-1114F H3 (Flood)</p>	 <p>Use H3 24V bulb Width 193mm, Height 93.3mm</p> <p><u>Part Number</u> SP NS-1115F H3 (Flood)</p>	 <p>Use H3 24V bulb</p> <p><u>Part Number</u> SP NS-1174F H3</p>
 <p>Use H3 24V bulb Width 188mm, Height 150mm</p> <p><u>Part Number</u> SP NS-1183F H3 (Flood) SP NS-1183S H3 (Spot)</p>	 <p>24V HID 167mmx177mmx121mm</p> <p><u>Part Number</u> SP NS-2503S HID</p>	 <p>Use H3 24V bulb</p> <p><u>Part Number</u> SP NS-2507F (Flood) SP NS-2507S (Spot)</p>

 <p>Use H3 24V bulb Double Beam 167.8mm x 116.5mm x 83mm</p> <p><u>Part Number</u> SP NS-2512F H3 (Flood) SP NS-2512S H3 (Spot)</p>	 <p>Use H3 24V bulb Width 174mm, Height 120mm</p> <p><u>Part Number</u> SP NS-1109F H3 (Flood)</p>	 <p>Use H3 24V bulb Rubber c Width 123mm, Height 172mm</p> <p><u>Part Number</u> SP AE-06-625 H3 (Flood)</p>
---	--	--

LED WORKING LAMP

 <p>LED Lamp 12/24V 2500 Lumen 170mmx76.5mm 10W LEDS X 5pcs Cree XML1 LED</p> <p><u>Part Number</u> SP NS-2560LED DV Spot SP NS-2561LED DV Flood</p>	 <p>LED Lamp 12/24V 760 Lumen 135mmx80mm 3W LEDS X 6pcs</p> <p><u>Part Number</u> SP NS-2520LED Flood SP NS-2521 LED Spot</p>	 <p>LED lamp 12/24V 1900 Lumen 3W LEDS X 16pcs</p> <p><u>Part Number</u> SP NS-2531BLED DV Spot SP NS-2540BLED DV Flood</p>
 <p>LED 9-33VDC 2000Lumen 10W LEDS X 4pcs Cree XML2 LED</p> <p><u>Part Number</u> SP NS-2555LED DV Spot SP NS-2556LED DV Flood</p>	 <p>LED 12V-64V 42 LED 560mm x 125mm x 90mm</p> <p><u>Part Number</u> SP C2-0305 DV</p>	 <p>LED Flood 12/24V 3W LEDS X 4pcs 600Lm</p> <p><u>Part Number</u> SP L80-00 LMV</p>
 <p>LED Flood 12/24V 3W LEDS X 8pcs 1200Lm</p> <p><u>Part Number</u> SP L81-00 LMV</p>	 <p>LED Flood 12/24V 3W LEDS X 6pcs 1500Lm</p> <p><u>Part Number</u> SP L82-00 LMV</p>	 <p>LED Flood 12/24V 3W LEDS X 12pcs 3000Lm</p> <p><u>Part Number</u> SP L83-00 LMV</p>
 <p>LED Flood 12/24V 3W LEDS X 18pcs 4500Lm</p> <p><u>Part Number</u> SP L84-00 LMV</p>	 <p>LED Flood 12/24V 20pcs LEDS 3000Lm</p> <p><u>Part Number</u> SP AE-06-675 LED</p>	 <p>LED Flood 12/24V 40pcs LEDS 6000Lm</p> <p><u>Part Number</u> SP AE-06-678 LED</p>

 <p>LED Flood 12/24V 30pcs LEDs 5400Lm</p> <p><u>Part Number</u> SP AE-06-685 LED</p>	 <p>LED Lamp 12/24V 3000 Lumen 167mmx105.8mm 10W LEDS X 6pcs Cree XML1 LED</p> <p><u>Part Number</u> SP NS-2553LED DV Spot SP NS-2550LED DV Flood</p>	 <p>LED Lamp 12/24V 5000 Lumen 10W LEDS X 9pcs Cree XML1 LED</p> <p><u>Part Number</u> SP NS-2551LED DV Spot SP NS-2559LED DV Flood</p>
 <p>LED Lamp 12/24V 1000 Lumen 10W LEDS X 2pcs Cree XML2 LED</p> <p><u>Part Number</u> SP NS-2568LED DV Spot SP NS-2569LED DV Flood</p>	 <p>HEL LED Lamp 12/24V 1800 Lumen 3W LEDS X 9pcs</p> <p><u>Part Number</u> SP LED-DP330S Spot SP LED-DP330F Flood</p>	 <p>HEL LED Lamp 12/24V 5000 Lumen 10W LEDS X 6pcs CREE LED</p> <p><u>Part Number</u> SP LED-DP1030F Flood</p>
 <p>HEL LED Lamp 12/24V 2500 Lumen 10W LEDS X 4pcs CREE LED</p> <p><u>Part Number</u> SP LED-DP1040F Flood</p>	 <p>HEL LED Lamp 12/24V 3400 Lumen 10W LEDS X 6pcs CREE LED</p> <p><u>Part Number</u> SP LED-DP1060F Flood</p>	 <p>HEL LED Lamp 12/24V 7000 Lumen 10W LEDS X 9pcs CREE LED</p> <p><u>Part Number</u> SP LED-DP1090F Flood</p>
 <p>HEL LED Lamp 12/24V 1200 Lumen 3W LEDS X 6pcs EPISTAR LED</p> <p><u>Part Number</u> SP LED-SL310F Flood</p>	 <p>HEL LED Lamp 12/24V 1800 Lumen 3W LEDS X 9pcs EPISTAR LED</p> <p><u>Part Number</u> SP LED-SL320F Flood</p>	 <p>HEL LED Lamp 12/24V 1800 Lumen 3W LEDS X 9pcs EPISTAR LED</p> <p><u>Part Number</u> SP LED-SL330S Spot SP LED-SL330F Flood</p>

 <p>HEL LED Lamp 12/24V 1800 Lumen 3W LEDs X 9pcs EPISTAR LED</p> <p><u>Part Number</u> SP LED-SL331S Spot SP LED-SL331F Flood</p>	 <p>HEL LED Lamp 12/24V 2200 Lumen 3W LEDs X 13pcs EPISTAR LED</p> <p><u>Part Number</u> SP LED-SL339F Flood</p>	 <p>HEL LED Lamp 12/24V 2900 Lumen 3W LEDs X 14pcs EPISTAR LED</p> <p><u>Part Number</u> SP LED-SL340F Flood</p>
 <p>HEL LED Lamp 12V HIGH = 5 HOUR</p> <p><u>Part Number</u> SP LED-SL350F Flood</p>	 <p>HEL LED Lamp 12/24V Forklift REVERSE WARNING LAMP</p> <p><u>Part Number</u> SP LED-SL420B</p>	 <p>HEL LED Lamp 12/24V 4000 Lumen 5W LEDs X 10pcs CREE LED</p> <p><u>Part Number</u> SP LED-SL550S Spot</p>
 <p>SP LED-SL320F 10-80V 9 X 3W LEDs</p>	 <p>SP LED-SL334F 10-80V 9 X 3W LEDs</p>	 <p>SP LED-VL192B MV 10-80V (Blue LED)</p>
 <p>SP LED-DP370F LED WORKING LAMP 12V/24V</p>	 <p>SP LED-DP820SF LED WORKING LAMP 12/24V</p>	 <p>SP LED-DP340F LED WORKING LAMP 12V/24V DP01-3W-42W 60D</p>

DRIVING LAMP

 <p>Driving Lamp Use H3 bulb</p> <p><i>Dia. 160mm, Height 176mm</i></p> <p><u>Part Number</u> SP NS-2160B-C 12V SP NS-2160B-C 24V</p>	 <p>HID Xenon Driving Lamp 12V</p> <p><i>192mm x 216mm x 116mm</i></p> <p><u>Part Number</u> SP NS-3703C HID</p>
--	--

LED DRIVING LAMP / LED DAYLIGHT DRIVING LAMP

 <p>LED Driving Lamp <i>ECE Compliant</i> 12/24V</p> <p><u>Part Number</u> SP NS-3723 LED DV</p>	 <p>LED Driving Lamp <i>ECE Compliant</i> 12/24V</p> <p><u>Part Number</u> SP NS-3711</p>	 <p>SP NS-4316 DV LED DRIVING LAMP HIGH/LOW 90MM</p>
---	--	---

BUS HEADLAMP

 <p>Headlamp for Buses Low Beam Lamp H7 Bulbs 24V</p> <p><u>Part Number</u> SP NS-4303L</p>	 <p>Headlamp for Buses High Beam Lamp H7 Bulbs 24V</p> <p><u>Part Number</u> SP NS-4305H</p>
--	---

LED BUS HEADLAMP







 <p>LED Headlamp for Buses Low Beam ECE- Compliant 12V/24V</p> <p><u>Part Number</u> SP NS-4306L</p>	 <p>LED Headlamp for Buses High Beam ECE- Compliant 12V/24V</p> <p><u>Part Number</u> SP NS-4305H</p>
---	--

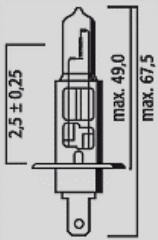
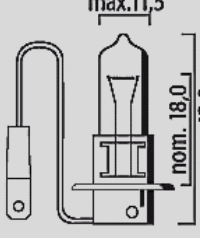
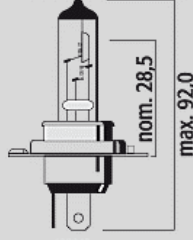
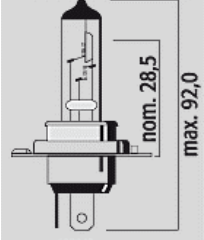
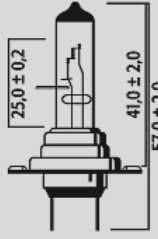
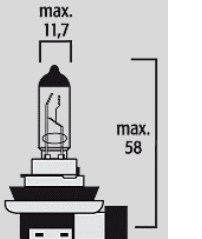
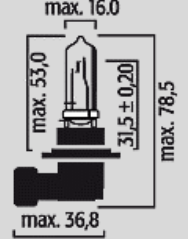
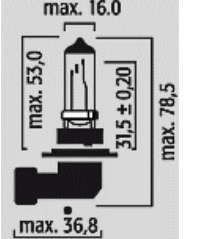
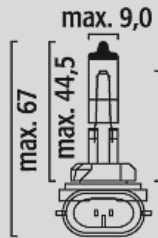
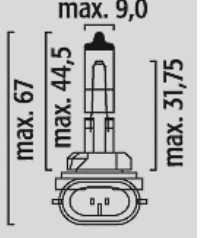
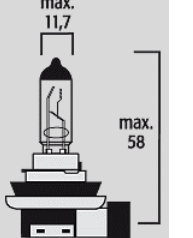
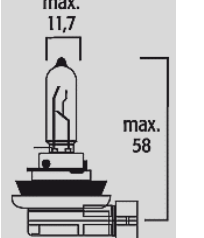



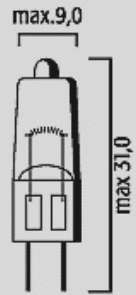
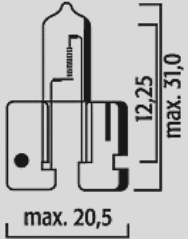
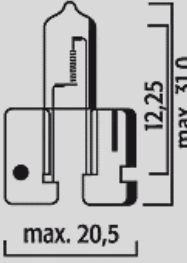
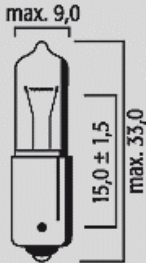
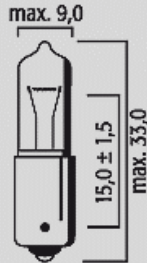
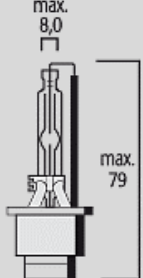
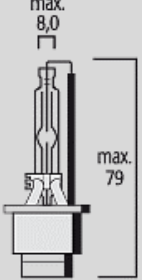
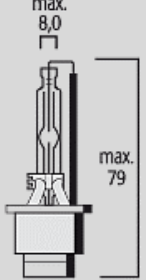

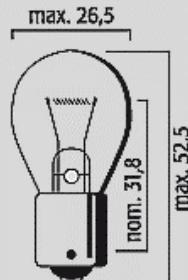
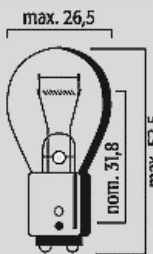
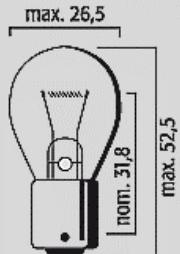
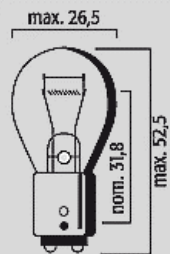
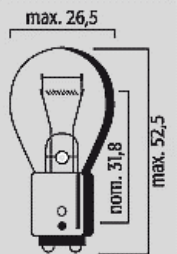

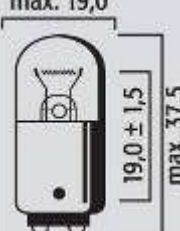
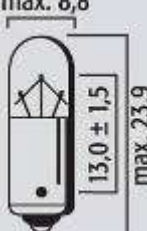
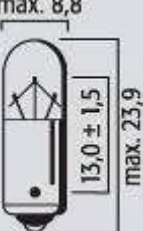
OTHER LED ACCESSORIES

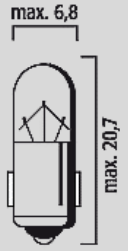
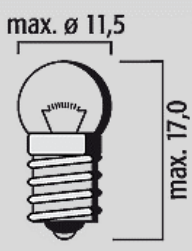
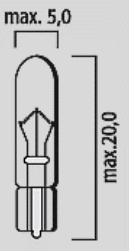
 <p>LED Light Bulb Part Number SP LED-VLB157 12V SP LED-VLB157 24V</p>	 <p>Pilot LED Lamp Diameter 12.5 mm Part No R9-100L 12V (R) Red R9-100L 12V (Y) Yellow R9-100L 24V (G) Green R9-100L 24V (R) Red R9-100L 24V (Y) Yellow</p>
--	--

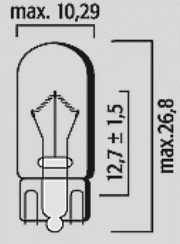
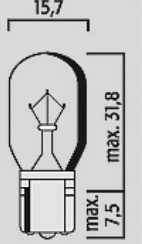
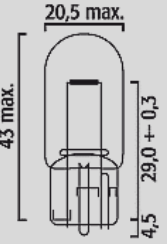
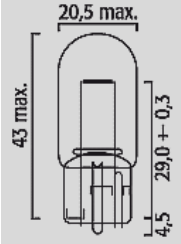
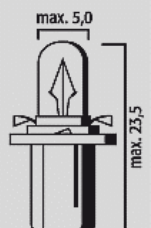
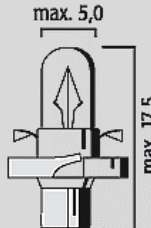

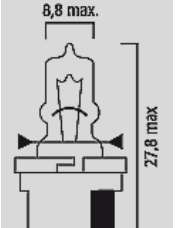
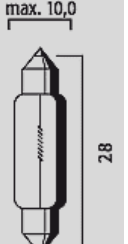
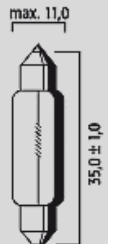
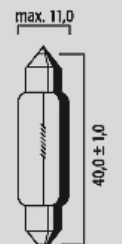













BULB

 <p>H1 Halogen Bulb H1 P14,5S</p> <table border="1"> <thead> <tr> <th>Part No</th> <th>Description</th> </tr> </thead> <tbody> <tr> <td>3021</td> <td>12V 55W</td> </tr> <tr> <td>13020</td> <td>12V 100W</td> </tr> <tr> <td>3024</td> <td>24V 70W</td> </tr> <tr> <td>13024</td> <td>24V 100W</td> </tr> </tbody> </table>	Part No	Description	3021	12V 55W	13020	12V 100W	3024	24V 70W	13024	24V 100W	 <p>H3 Halogen Bulb H3 PK22S</p> <table border="1"> <thead> <tr> <th>Part No</th> <th>Description</th> </tr> </thead> <tbody> <tr> <td>3320</td> <td>12V 55W</td> </tr> <tr> <td>13320</td> <td>12V 100W</td> </tr> <tr> <td>3324</td> <td>24V 70W</td> </tr> <tr> <td>13324</td> <td>24V 100W</td> </tr> </tbody> </table>	Part No	Description	3320	12V 55W	13320	12V 100W	3324	24V 70W	13324	24V 100W	 <p>H4 Halogen Bulb H4 P43T</p> <table border="1"> <thead> <tr> <th>Part No</th> <th>Description</th> </tr> </thead> <tbody> <tr> <td>6255/43</td> <td>12V 60/55W</td> </tr> <tr> <td>0456E</td> <td>12V 60/55W</td> </tr> <tr> <td>0443E</td> <td>12V 100/90W</td> </tr> <tr> <td>H4.U.</td> <td>12V 110/110W</td> </tr> <tr> <td>8255/43</td> <td>24V 75/70W</td> </tr> <tr> <td>0468E</td> <td>24V 75/70W</td> </tr> </tbody> </table>	Part No	Description	6255/43	12V 60/55W	0456E	12V 60/55W	0443E	12V 100/90W	H4.U.	12V 110/110W	8255/43	24V 75/70W	0468E	24V 75/70W	 <p>H4 Halogen Bulb H4 P45T</p> <table border="1"> <thead> <tr> <th>Part No</th> <th>Description</th> </tr> </thead> <tbody> <tr> <td>6255/45</td> <td>12V 60/55W</td> </tr> <tr> <td>8255/45</td> <td>24V 75/70W</td> </tr> </tbody> </table>	Part No	Description	6255/45	12V 60/55W	8255/45	24V 75/70W
Part No	Description																																										
3021	12V 55W																																										
13020	12V 100W																																										
3024	24V 70W																																										
13024	24V 100W																																										
Part No	Description																																										
3320	12V 55W																																										
13320	12V 100W																																										
3324	24V 70W																																										
13324	24V 100W																																										
Part No	Description																																										
6255/43	12V 60/55W																																										
0456E	12V 60/55W																																										
0443E	12V 100/90W																																										
H4.U.	12V 110/110W																																										
8255/43	24V 75/70W																																										
0468E	24V 75/70W																																										
Part No	Description																																										
6255/45	12V 60/55W																																										
8255/45	24V 75/70W																																										
 <p>H7 Halogen Bulb H7 PX26D</p> <table border="1"> <thead> <tr> <th>Part No</th> <th>Description</th> </tr> </thead> <tbody> <tr> <td>2070</td> <td>12V 55W</td> </tr> <tr> <td>0986-AL1-524</td> <td>12V 55W</td> </tr> <tr> <td>2470</td> <td>24V 70W</td> </tr> <tr> <td>247022</td> <td>24V 70W heavy duty</td> </tr> </tbody> </table>	Part No	Description	2070	12V 55W	0986-AL1-524	12V 55W	2470	24V 70W	247022	24V 70W heavy duty	 <p>H11 Halogen Bulb H11 PGJ19-2</p> <table border="1"> <thead> <tr> <th>Part No</th> <th>Description</th> </tr> </thead> <tbody> <tr> <td>0110</td> <td>12V 55W</td> </tr> <tr> <td>H11</td> <td>24V 70W</td> </tr> <tr> <td></td> <td>24V 70W</td> </tr> </tbody> </table>	Part No	Description	0110	12V 55W	H11	24V 70W		24V 70W	 <p>HB3 Halogen Bulb HB3 P20D</p> <table border="1"> <thead> <tr> <th>Part No</th> <th>Description</th> </tr> </thead> <tbody> <tr> <td>0473</td> <td>12V 60W</td> </tr> </tbody> </table>	Part No	Description	0473	12V 60W	 <p>HB4 Halogen Bulb HB4 P22D</p> <table border="1"> <thead> <tr> <th>Part No</th> <th>Description</th> </tr> </thead> <tbody> <tr> <td>0474</td> <td>12V 51W</td> </tr> </tbody> </table>	Part No	Description	0474	12V 51W														
Part No	Description																																										
2070	12V 55W																																										
0986-AL1-524	12V 55W																																										
2470	24V 70W																																										
247022	24V 70W heavy duty																																										
Part No	Description																																										
0110	12V 55W																																										
H11	24V 70W																																										
	24V 70W																																										
Part No	Description																																										
0473	12V 60W																																										
Part No	Description																																										
0474	12V 51W																																										
 <p>H27W/2 Halogen Bulb PGJ13</p> <table border="1"> <thead> <tr> <th>Part No</th> <th>Description</th> </tr> </thead> <tbody> <tr> <td>881</td> <td>12V 27W</td> </tr> </tbody> </table>	Part No	Description	881	12V 27W	 <p>H50W/2 Halogen Bulb PGJ13</p> <table border="1"> <thead> <tr> <th>Part No</th> <th>Description</th> </tr> </thead> <tbody> <tr> <td>881</td> <td>12V 50W</td> </tr> </tbody> </table>	Part No	Description	881	12V 50W	 <p>H8 Halogen Bulb PGJ19-1</p> <table border="1"> <thead> <tr> <th>Part No</th> <th>Description</th> </tr> </thead> <tbody> <tr> <td>2080</td> <td>12V 35W</td> </tr> </tbody> </table>	Part No	Description	2080	12V 35W	 <p>H9 Halogen Bulb PGJ19-5</p> <table border="1"> <thead> <tr> <th>Part No</th> <th>Description</th> </tr> </thead> <tbody> <tr> <td>2090</td> <td>12V 65W</td> </tr> </tbody> </table>	Part No	Description	2090	12V 65W																								
Part No	Description																																										
881	12V 27W																																										
Part No	Description																																										
881	12V 50W																																										
Part No	Description																																										
2080	12V 35W																																										
Part No	Description																																										
2090	12V 65W																																										

 <p>H3C Halogen Bulb PK-22SS</p> <p><u>Part No</u> <u>Description</u> 0452 12V 55W</p>	 <p>H6 Halogen Bulb</p> <p><u>Part No</u> <u>Description</u> 14-0370 12V 65/55W</p>	 <p>Miniature Halogen Bulb G4</p> <p><u>Part No</u> <u>Description</u> 2074220 12V 20W 2074420 24V 20W</p>	 <p>H2 Halogen Bulb X511</p> <p><u>Part No</u> <u>Description</u> 3420 12V 55W 13420 12V 100W</p>
 <p>H2 Halogen Bulb X511</p> <p><u>Part No</u> <u>Description</u> 3720 24V 70W</p>	 <p>Miniature Halogen Bulb BA9S</p> <p><u>Part No</u> <u>Description</u> 4005 12V 5W 4010 12V 10W 4020 12V 20W</p>	 <p>H6W Miniature Halogen Bulb H6W BAX9s</p> <p><u>Part No</u> <u>Description</u> 4006 12V 6W</p>	 <p>D2S 4200°K Xenon Bulb P32D-2</p> <p><u>Part No</u> <u>Description</u> 85422 85V 35W</p>
 <p>D2R 4200°K Xenon Bulb P32D-3</p> <p><u>Part No</u> <u>Description</u> 85426 85V 35W</p>	 <p>D4S Xenon Bulb P32D-5</p> <p><u>Part No</u> <u>Description</u> D4S 42V 35W</p>	 <p>Headlight Bulb R2 P45T</p> <p><u>Part No</u> <u>Description</u> 3940/P45T 12V 45/40W 3770/P45T 24V 55/50W</p>	 <p>Stop /Flashing Light <u>Part No</u> <u>Description</u> P21W BA15S 6671/667107 12V 21W/amber 6652/665207 24V 21W/amber 1141 48V 25W PY21W BAU15S 667101 12V 21W orange 665201 24V 21W orange</p>
 <p>Stop Light & Flashing Light 1142 BA15D</p> <p><u>Part No</u> <u>Description</u> 6674 12V 21W 6654 24V 21W</p>	 <p>Stop Light & Flashing Light 1073 BA15S</p> <p><u>Part No</u> <u>Description</u> 8671 12V 25W 8652 24V 25W</p>	 <p>Stop Light & Tail Lamp Bulb 1016 BAY15D</p> <p><u>Part No</u> <u>Description</u> 5229 12V 21/5W 522907 12V 21/5W amber 5230 12V 32/4CP 5239 24V 21/5W 5249 24V 25/5W 1016 48V 25/10W</p>	 <p>Stop Light & Tail Lamp Bulb P21/4W BAZ15D</p> <p><u>Part No</u> <u>Description</u> 5329 12V 21/4W 5339 24V 21/4W</p>
 <p>Tail Lamp Bulb BA15S</p> <p><u>Part No</u> <u>Description</u> 4025 12V 5W R5W 14025 12V 10W R10W 4052 24V 5W R5W 14052 24V 10W R10W</p>	 <p>Indicator Light Bulb R5W BA15D</p> <p><u>Part No</u> <u>Description</u> 4425 12V 5W 4452 24V 5W</p>	 <p>Indicator Light Bulb BA9S</p> <p><u>Part No</u> <u>Description</u> 4038 12V 2W 4008 24V 2W</p>	 <p>Indicator Light Bulb T4W BA9S</p> <p><u>Part No</u> <u>Description</u> 4088 12V 4W 408833 12V 4W 4080 24V 4W</p>















 <p>Indicator Light Bulb BA7s</p> <p><u>Part No</u> <u>Description</u> 4051 12V 2W 4048 24V 3W</p>	 <p>Indicator Light Bulb E10</p> <p><u>Part No</u> <u>Description</u> 4045 12V 3W 4046 24V 3W</p>	 <p>Indicator Light Bulb T5 W2x4,6d</p> <p><u>Part No</u> <u>Description</u> 4191 12V 1.2W 419106 12V 1.2W frosted 4391 12V 2W 4192 24V 1.2W</p>	 <p>Indicator Light Bulb T7</p> <p><u>Part No</u> <u>Description</u> 1590 T7 12V 3W</p>
 <p>Indicator Light Bulb W2,1x9,5d</p> <p><u>Part No</u> <u>Description</u> 4090 12V 3W W3W 4092 24V 3W W3W 4291 12V 5W W5W 429101 12V 5W W5W 429133 12V 5W W5WBlue 4292 24V 5W</p>	 <p>Indicator Light Bulb W16W T15</p> <p><u>Part No</u> <u>Description</u> 921 12V 25W</p>	 <p>Indicator Light Bulb W21W T20</p> <p><u>Part No</u> <u>Description</u> 1881 / W7575 12V 21W 1870 12V 21W amber</p>	 <p>Indicator Light Bulb W21/5W T20 W3x16q</p> <p><u>Part No</u> <u>Description</u> 1891 12V 21/5W</p>
 <p>Indicator Light Bulb B8,5d with plastic base</p> <p><u>Part No</u> <u>Description</u> 419101 12V 1.2W black 439101 12V 2W green 419201 24V 1.2W grey</p>	 <p>Indicator Light Bulb BX8,4d with plastic base</p> <p><u>Part No</u> <u>Description</u> 419103 12V 1.2W black 439103 12V 2W green</p>	 <p>Indicator Light Bulb HRQ with plastic base</p> <p><u>Part No</u> <u>Description</u> 449105 14V 1.4W black</p>	 <p>Indicator Light Bulb B10d Halogen with plastic base</p> <p><u>Part No</u> <u>Description</u> 429180 12V 5W</p>
 <p>Festoons Bulb SV8,5 10x28mm</p> <p><u>Part No</u> <u>Description</u> 5168 12V 10W</p>	 <p>Festoons Bulb SV8,5 C5W 11x35mm</p> <p><u>Part No</u> <u>Description</u> 4033 12V 5W 4002 24V 5W 403310 12V 10W</p>	 <p>Festoons Bulb SV8,5 11x40mm</p> <p><u>Part No</u> <u>Description</u> 4230 12V 5W 4206 24V 5W 4231 12V 10W 4210 24V 10W</p>	 <p>85410 4200K HIGH INTENSITY DISCHARGE</p> <p><u>Description</u> 85V 35W</p>
 <p>42322 4200K HIGH INTENSITY DISCHARGE</p> <p><u>Description</u> 42V 35W</p>	 <p>42522 5000K HIGH INTENSITY DISCHARGE</p> <p><u>Description</u> 42V 35W</p>		

BULB SOCKET



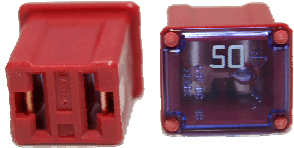





 <p>Socket for T20 Bulb <u>Part No</u> <u>Description</u> 2444 Single Filament (Signal Light)</p>	 <p>Socket for T20 Bulb <u>Part No</u> <u>Description</u> 2644 Double Filament (Brake light)</p>	 <p>Socket for 1141 Bulb <u>Part No</u><u>Description</u> 6444 Single Filament</p>	 <p>Socket for 1016 Bulb <u>Part No</u> <u>Description</u> 5444 Double Filament</p>
 <p>Socket for T5 Bulb <u>Part No</u> LS-9S</p>	 <p>Socket for T10 Bulb <u>Part No</u> LS-9M</p>	 <p>Socket for H1 Bulb <u>Part No</u> 1444</p>	 <p>Socket for H1 Bulb <u>Part No</u> 1445</p>
 <p>Socket for HB4 Bulb <u>Part No</u> 9446</p>	 <p>Socket for H4 Bulb High Temperature resistant <u>Part No</u> 4444</p>	 <p>Socket for H4 Bulb <u>Part No</u> LS-14</p>	 <p>Socket for H7 Bulb <u>Part No</u> 7444</p>
 <p>Socket for H8, H9, H11 Bulb <u>Part No</u> 9448</p>	 <p>Socket for HB3, H10, H12 <u>Part No</u> 9445</p>	 <p>Socket for W2, 1X9, 5D Bulb <u>Part No</u> 4244</p>	 <p>Socket for W2, 1X9, 5D Bulb <u>Part No</u> 4245</p>

FUSE

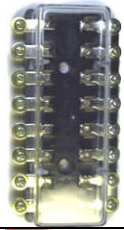

 <p>Ceramic Fuse <u>Part No</u> <u>Description</u> F.114808 White 8A F.114816 Red 16A F.104825 Blue 25A F.104840 Blue 40/25A 124800 Holder for F.1048xx</p> <p>Size 6x25</p>	 <p>Mini Plug in Fuse <u>Part No</u> <u>Description</u> F.4703 Violet 3A F.4705 Light Brown 5A F.4707 Brown 7.5A F.4710 Red 10A F.4715 Light Blue 15A F.4720 Yellow 20A F.4725 White 25A F.4730 Green 30A</p> <p>Size 11.5x15.70</p>  <p>FUSE (SET) <u>Part No</u> F.447(SET)100 (R) (3A TO 30A = 100PCS) (6307 Fuse Holder)</p>	 <p>Low Profile Mini Plug in Fuse <u>Part No</u> <u>Description</u> F.503805 Light Brown 5A F.503875 Brown 7.5A F.503810 Red 10A F.503815 Light Blue 15A F.503820 Yellow 20A F.503825 White 25A F.503830 Green 30A</p> <p>Size 11x9</p>	 <p>Plug in Fuse <u>Part No</u> <u>Description</u> F.214801 Black 1A F.214803 Violet 3A F.4607 Brown 7.5A F.4610 Red 10A F.4615 Blue 15A F.4620 Yellow 20A F.4625 White 25A F.204830 Green 30A F.214840 Orange 40A FUSE (SET) <u>Part No</u> F.446(SET)120 (R) (3A TO 30A = 120pcs) F.446(SET)422 (R) (1A TO 40A = 422pcs) (6306 Fuse Holder)</p> <p>Size 19x20</p> 
---	---	---	---

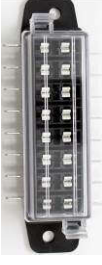

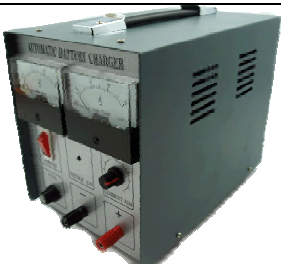

 <p>Big Plug in Fuse <u>Part No</u> <u>Description</u> F.314840 Orange 40A F.314850 Red 50A F.314880 White 80A F.3148100 Violet 100A 324844 Fuse Holder Size 30x33.5</p>	 <p>European Main Fuse Screw Type <u>Part No</u> <u>Description</u> F.373150L Red 50A F.373180L White 80A F.373100L Blue 100A F.7048125 Pink 125A F.7048150 Grey 150A (724800 Fuse Holder) Size 12x42</p>	 <p>European Main Fuse Screw Type <u>Part No</u> <u>Description</u> F.8048100 Blue 100A F.8048125 Green 125A F.8048150 Orange 150A F.8048300 Red 300A (888800 Fuse Holder) Size 16.3x67.5</p>	 <p>Glass Fuse <u>Part No</u> <u>Description</u> F.4010 Red 10 A F.4020 Yellow 20A F.4025 Green 25A F.4035 35A</p>
 <p>Slow Blow Fuse Type A <u>Part No</u> <u>Description</u> F.3038 Pink 30A F.3048 Green 40A F.3058 Red 50A F.3068 Yellow 60A</p>	 <p>Slow Blow Fuse Type B <u>Part No</u> <u>Description</u> F.3138 Pink 30A F.3148 Green 40A F.3158 Red 50A F.3168 Yellow 60A F.3188 Black 80A F.3101 Blue 100A F.3102 White 120A</p>	 <p>Slow Blow Fuse Type C <u>Part No</u> <u>Description</u> F.3238 Pink 30A F.3248 Green 40A F.3258 Red 50A F.3268 Yellow 60A F.3278 Brown 70A F.3288 Black 80A F.32101 Blue 100A</p>	 <p>S. Blow Fuse Type CS <u>Part No</u> <u>Description</u> F.3330CS Pink 30A F.3340CS Green 40A F.3350CS Red 50A F.3360CS Yellow 60A F.3370CS Brown 70A F.3380CS Black 80A F.3301CS Blue 100A</p>
 <p>Slow Blow Fuse Type D <u>Part No</u> <u>Description</u> F.3321D Brown 25A F.3331D Green 30A</p>	 <p>Slow Blow Fuse Type E <u>Part No</u> <u>Description</u> F.3445E Red 45A F.3465E Black 65A F.3475E Grey 75A</p>	 <p>Slow Blow Fuse Type G <u>Part No</u> <u>Description</u> F.3402G 120A</p>	 <p>Slow Blow Fuse Type J <u>Part No</u> <u>Description</u> F.3482J 20A F.3483J 30A F.3484J 40A F.3485J 50A F.3486J 60A</p>
 <p>Slow Blow Fuse Type JS (short) <u>Part No</u> <u>Description</u> F.34892JS 20A F.34893JS 30A F.34894JS 40A F.34895JS 50A F.34896JS 60A</p>	 <p>FUSIBL LINK WIRES 16GA 10FT 0.28MMX19 1.25MM BLACK <u>Part No</u> F.1.25WL125-00000</p>	 <p>FUSIBL LINK WIRES 18GA 10FT 0.23MMX19 0.85MM RED <u>Part No</u> F.085 WL085-00200</p>	 <p>Fuses HSB Type <u>Part No</u> <u>Description</u> F.39030 30A F.39040 40A F.39050 50A F.39060 60A F.39090 80A</p>
 <p>Fuses Strips <u>Part No</u> <u>Description</u> F.38100 100A F.38125 125A F.38150 150A</p>	 <p>Screw Fuse <u>Part No</u> <u>Description</u> F.ANG-275 275A F.ANG-300 300A</p>	 <p>Fuse Puller & Tester W/Led <u>Part No</u> F.100-998 for mini plug in fuse F.47xx F.100-999 for plug in fuse F.46xx</p>	

FUSE HOLDER







 <p>Fuse Holder with light for Plug in Fuse Part No R3-59A for F.46xx (30A max) R3-60A for F.47xx (30A max) R3-60D for F.47xx (10A max)</p>	 <p>Fuse Holder for Plug in Fuse F.46XX (19x20) Water Resistance Part No 6306. FUSE HOLDER</p>	 <p>Fuse Holder for Plug in Fuse F.46XX (19x20) Can be connected together Part No 610502</p>	 <p>Fuse Holder for Plug in Fuse F.46XX (19x20) Can be connected to Relay Holder 3334-485-008 Part No 2211</p>
 <p>Fuse Holder for Ceramic Fuse Part No 124800</p>	 <p>Fuse Holder for Big Plug in Fuse F.3048XX Part No 324844</p>	 <p>Fuse Holder for Main Fuse Screw Type (Small) F.7048XXX Part No 724800</p>	 <p>Fuse Holder for Main Fuse Screw Type (Big) F.8048XXX Part No 888800</p>
 <p>Fuse Holder for Glass Fuse F.40XX 10 Fuse-Fuse Box Part No FT10</p>	 <p>Fuse Holder for Glass Fuse F.40XX 6 Fuse-Fuse Box Part No FT6</p>	 <p>Fuse Holder for Glass Fuse F.40XX 8 Fuse-Fuse Box Part No FT26</p>	 <p>Fuse Holder for Glass Fuse F.40XX 8 Fuse-Fuse Box Part No F100</p>
 <p>Fuse Boxes For F.46xx Part No ATY-N202-08KW (8 Way Terminals) ATY-N202-10KW (10 Way Terminals) ATY-N202-12KW (12 Way Terminals)</p>	 <p>Fuse Boxes For F.46/47xx Part No ATY-N202-08T (8 Way Terminals) ATY-N202-10T (10 Way Terminals)</p>	 <p>Fuse Holder W/Wire (For F.46xx) Waterproof MAX.30A Part No ATY-N202-312</p>	 <p>Fuse Holder for Glass Fuse F.40XX (Max 30A) Part No R3-64 Clip Type GFB0 Screw Type</p>

Battery Charger

 <p>Float Battery Charger (Slow Charge) 12V Part No KT-CH2112 12V 10AMP Part No KT-CH2124 24V 10AMP</p>	 <p>3-stage Battery Charger (Fast Charge) 12V Part No CHR-2415 24V 15A</p>	 <p>Battery Charger 12/24V 12A Part No CD32A 12/24V12A</p>
--	--	---

 <p>Battery Charger 12v Charger W/Low Batt Sensor</p> <p>Part No KT-CH4612</p>	 <p>Battery Charger 12v 10a</p> <p>Part No CHR-1210-A</p>	 <p>Battery Charger 24v 20a</p> <p>Part No CHR-2420-A</p>
 <p>CHR-122407 BATTERY CHARGER 12/24V 7A</p>	 <p>CHR-122430A BATTERY CHARGER 12/24 30A</p>	

Converter

 <p>24VDC to 12VDC</p> <p>Part No DDS212 output 12V 10A DDS230 output 12V 30A DC-130BP output 12V 10A</p>	 <p>24VDC to 12VDC 10A</p> <p>Part No DC-130BP</p>	 <p>24VDC to 12VDC</p> <p>Part No SE-30A 30Amp SE-60A 60Amp</p>
 <p>DC12V to DC24V DC CONVERTER 10A (W/NOLSE FILTER)</p> <p>Part No DC-180</p>	 <p>DC-AC INVERTER 1500W Remote Control FPC-RC DC to AC240V</p> <p>Part No FPC-1500W-12V (DC12V to AC240V) FPC-1500W-24V (DC24V to AC240V)</p>	 <p>DC24V to AC240V</p> <p>Part No HASO-8022</p>

Power Booster (SOS)



 <p>12V/1200A 24V/600A</p> <p>Part No SOS BP1190</p>	 <p>12V/24V 2300Amp LI-ION Booster</p> <p>Part No SOS MB322J</p>	 <p>12V/24V 2000Amp</p> <p>Part No SOS MD340J</p>
--	--	--

TOOLS

<p>VOLTAGE TESTER 183044 6-24V</p> 	<p>Clamping Tool ITM KH-503</p> 	<p>Clamping Tool ITM LY-03J</p> 	<p>Acuangle Level ITM A-100</p> 	<p>Checker for Mazda Alternator (P,D terminal) CN002</p> 	<p>Screw Driver Set ITM 1006N</p> 
<p>PENETRANT 400ML Lubricants/ Rust Prevention Super Lubricant</p> 	<p>Clutch Pulley Tool PULLEY TOOL</p> 	<p>Electrical Insulation Tape Black Deer Tape 0.008X3/4 X 10YDS</p> 	<p>Electrical Insulation Tape 3MTape Red 0.177X19X 20M</p> 	<p>3M SCOTCH-23B Self-bolding tape</p> 	<p>ITM INSULATION Electrical Insulation paper</p> 
<p>POWER ADAPTER 181412</p> 	<p>POWER PLUG 12/24V 8A 181420</p> 	<p>GADUS S3 T220-2 Shell Bearing Grease</p> 		<p>AE-78-020 UNDER CARRIAGE SLIDE</p>	

SOLDERING

 <p>Tin/Lead Solder SN60 / PB40 Rosin Activated Core Wire Part Number 500G16D-WC60B16E 1/2kg 1.6mm 500G20D-WC60B20E 1/2kg 2.0mm 1KG16D-WC60B16D 1kg 1.6mm 1KG20D-WC60B20D 1kg 2.0mm</p>	 <p>Lead-Free Solder Tin 99.3% / Copper 0.7% Part Number (500g) 500G10D-WL993C07E (1.0mm)</p>	 <p>Soldering Flux 100</p>
 <p>Soldering Iron Part Number HP-200 240V 200W HP-300 240V 300W</p>	 <p>Soldering Iron Part Number TQ-95 240V 20/200W</p>	 <p>Soldering Iron Part Number TQ-77 240V 200W</p>

 <p>Gas Soldering Iron - Portable - Can be used as blow torch - One touch ignition switch - Quick heating - Power equivalent to 25-125W - Made in Ireland</p> <p><u>Part Number</u> GP501</p>	 <p>Desoldering Pump</p> <p><u>Part Number (Small)</u> ITM DS-4</p>	 <p>Desoldering Pump</p> <p><u>Part Number (Big)</u> GS-100</p>
--	--	---

SYSTEM TESTER









Part No: 0986-AT0-108 Bosch ECU Diagnosis for Japanese Cars





Fast and Efficient ECU Diagnosis:
The KT 310 with simple user interface for modern vehicle service workshops



BOSCH





WIRE/CABLE

 <p>Wire Speaker W-12/.18x2C 100metre W-30/.18x2C 100metre</p>	 <p>Wire Transparent Sheathed W-23/.14X2C Black 100metre W-23/.14x2C White 100metre</p>	 <p>7 Core Wire W-7Core T/C 20" (6.15metre)</p>
 <p>Welding Cable W.-WC-35MMSQ 400A W.-WC-50MMSQ 500A</p>	 <p>Battery Cable (30metre per roll) W.>25 SQ MM 60A W.>50 SQ MM 120A W.>70 SQ MM 170A W.>95 SQ MM 210A</p>	 <p>Auto Wire (30 metre per roll) W.14/026 W.28/026 W.35/026 W.44/026 W.65/026 W.100/026</p>
 <p>Booster Clip HPC100 100Amp HPC200 200Amp</p>	 <p>Fully insulated Battery Clip (small) <u>Part Number</u> R8-110 (+/-) SET</p>	 <p>Battery Clip (small) <u>Part Number</u> H147 (+/-) SET</p>

 <p>Booster Cable 200A 10 feet booster Cable 200A 12 feet booster Cable 200A 15 feet booster Cable 200A 20 feet booster Cable 200A 30 feet booster Cable</p>	<p>Cleaner Fast Orange Cleaner</p> 	
---	---	--

Battery Clamp/Cable Lug

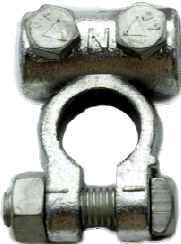
<p>Value for Money</p> <p>S005, S006 (small) MC-005, MC-006</p> 	<p>Battery Clamp</p> <p>S007, MC-007</p> 	<p>Cable Lug</p> <table border="1"> <thead> <tr> <th>Cable SQ. MM</th> <th>Stud Hole Size</th> <th>Part No</th> </tr> </thead> <tbody> <tr><td>25</td><td>6.5</td><td>ITM 25-6</td></tr> <tr><td>35</td><td>6.5</td><td>ITM 35-6</td></tr> <tr><td>35</td><td>8.4</td><td>ITM 35-8</td></tr> <tr><td>50</td><td>8.4</td><td>ITM 50-8</td></tr> <tr><td>50</td><td>10.5</td><td>ITM 50-10</td></tr> <tr><td>70</td><td>10.5</td><td>ITM 70-10</td></tr> <tr><td>70</td><td>13</td><td>ITM 70-12</td></tr> <tr><td>95</td><td>10.5</td><td>ITM 95-10</td></tr> <tr><td>95</td><td>13</td><td>ITM 95-12</td></tr> </tbody> </table>	Cable SQ. MM	Stud Hole Size	Part No	25	6.5	ITM 25-6	35	6.5	ITM 35-6	35	8.4	ITM 35-8	50	8.4	ITM 50-8	50	10.5	ITM 50-10	70	10.5	ITM 70-10	70	13	ITM 70-12	95	10.5	ITM 95-10	95	13	ITM 95-12	
Cable SQ. MM	Stud Hole Size	Part No																															
25	6.5	ITM 25-6																															
35	6.5	ITM 35-6																															
35	8.4	ITM 35-8																															
50	8.4	ITM 50-8																															
50	10.5	ITM 50-10																															
70	10.5	ITM 70-10																															
70	13	ITM 70-12																															
95	10.5	ITM 95-10																															
95	13	ITM 95-12																															

<p>Heavy Duty</p> <p>SL2302P(+) SL2302N(-)</p> 	<p>Battery Clamp</p> <p>SL2308P(+) SL2308N(-)</p> 	<p>SL2074P(+) SL2074N(-)</p> 	<p>SL2202P(+) SL2202N(-)</p> 	<p>Super Heavy Duty</p> <p>SL2802P(+) SL2802N(-)</p> 	<p>Battery Clamp</p> <p>SL2308P(+) SL2308N(-)</p> 
--	--	--	--	---	--

 <p>RB2202LB</p>	 <p>RB2202LR</p>	<p>Battery Clamp Cover</p>  <p>RB4202LB</p>	 <p>RB4202LR</p>	 <p>RB6802TB</p>	 <p>RB6802TR</p>
--	---	--	---	---	---

SOCKET/TERMINAL/CONNECTOR

 <p>Truck Connector DIN 72579 ISO 1185</p> <p><u>Part No</u> 090-157-112</p>	 <p>Rubber Seal For Truck Connector 090-157-112</p> <p><u>Part No</u> 090-157-913</p>	 <p>Truck Connector DIN 72579 ISO 1185</p> <p><u>Part No</u> 090-157-715</p>																								
 <p>Battery Connector <u>Part No</u> 090-198-050 50A 090-198-060 175A 090-198-070 350A</p>	 <p>Cable Tie Available in White/Black and different lenght 150mm , 200mm, 280mm 300mm, 310mm, 385mm</p>	 <table border="1"> <thead> <tr> <th colspan="3">Connector</th> </tr> <tr> <th>PIN</th> <th>FEMALE</th> <th>MALE</th> </tr> </thead> <tbody> <tr> <td>1</td> <td>C.1F</td> <td>C.1M</td> </tr> <tr> <td>2</td> <td>C.2F</td> <td>C.2M</td> </tr> <tr> <td>3</td> <td>C.3F</td> <td>C.3M</td> </tr> <tr> <td>4</td> <td>C.4F</td> <td>C.4M</td> </tr> <tr> <td>6</td> <td>C.6F</td> <td>C.6M</td> </tr> <tr> <td>8</td> <td>C.8F</td> <td>C.8M</td> </tr> </tbody> </table>	Connector			PIN	FEMALE	MALE	1	C.1F	C.1M	2	C.2F	C.2M	3	C.3F	C.3M	4	C.4F	C.4M	6	C.6F	C.6M	8	C.8F	C.8M
Connector																										
PIN	FEMALE	MALE																								
1	C.1F	C.1M																								
2	C.2F	C.2M																								
3	C.3F	C.3M																								
4	C.4F	C.4M																								
6	C.6F	C.6M																								
8	C.8F	C.8M																								

PK-BELT

	<p>SUN Brand PK V-Ribbed belts 100% Made in Japan</p> <ul style="list-style-type: none"> - Manufactured by the top power transmission belt manufacturer in Japan. (Certified ISO/TS16949, ISO9001:2008, JIS-Q9001:2008) - Wide variety of sizes covering most of the applications. - Compatible to O.E. standard specification <p>Size 3PK to 8 PK</p>
--	--

TERMINAL

Wire Range qmm	Colour	Dimensions' m/m			Part No.
		L	W	D	
22-18 0.25-1.5	Red	21.0	8.0	4.3	ITM 4R
	Red	21.0	8.0	5.3	ITM 5R
6-14 1.5-2.5 mm2	Blue	21.7	8.5	4.3	ITM 4B
	Blue	22.3	9.6	5.3	ITM 5B
	Blue	27.2	12.0	6.4	ITM 6B
	Blue	27.2	12.0	8.4	ITM 8B
12-10 2.5-6.0 mm2	Yellow	24.7	9.5	4.3	ITM 4Y
	Yellow	24.7	9.5	5.3	ITM 5Y
	Yellow	31.0	12.0	6.4	ITM 6Y
	Yellow	34.0	15.0	8.4	ITM 8Y
	Yellow	34.0	15.0	10.5	ITM 10Y
	Yellow				ITM 11Y

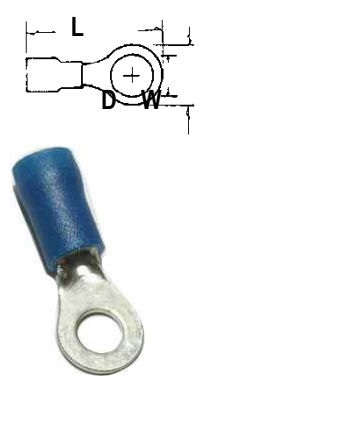

Wire Range	Color	Dimension'			Part No
		L	W	D	
22-16 0.5-1.5mm2	Red	21.5	7.2	4.3	ITM 43R
16-14 1.5-2.5 mm2	Blue	21.5	7.2	4.3	ITM 43B
16-14 1.5-2.5 mm2	Blue	21.5	8.0	5.2	ITM 21B
12-10 2.5-6.0 mm2	Yellow	24.5	9.0	5.2	ITM 24Y

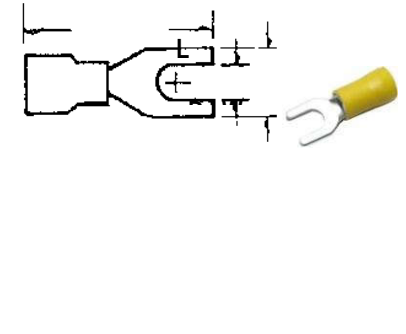

Wire Range	Color	Dimension'	Part Number
16-14	Blue	6.3 x 0.8	ITM F260BC
12-10	Yellow	6.3 x 0.8	ITM F260YC



Wire Range	Color	Dimension' m/m	Part Number
16-14	Blue	L21.7 W5.50	ITM F300BC
22-18	Red	L20.7 W5.50	ITM F300RC
12-10	Yellow	L23.7 W5.50	ITM F300YC

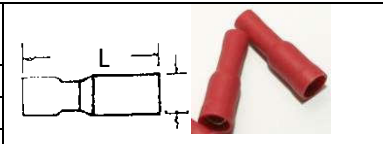

Wire Range	Color Code	Dimension' m/m	Part Number
16-14	Blue	L21.7 W4.74	ITM M290BC
22-18	Red	L20.7 W4.74	ITM M290RC
12-10	Yellow	L23.7 W4.74	ITM M290YC

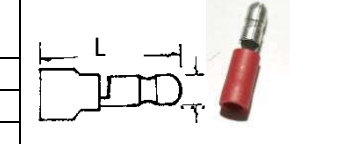

Wire Range	Color Code	Dimension' m/m	Part Number
16-14	Blue	6.3 x 0.8	ITM M250BC
12-10	Yellow	6.3 x 0.8	ITM M250YC

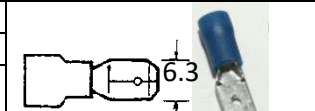

ITM FDFD1-250 ITM FDFD2-250 ITM FDFD5-250(small) ITM FDFD5-375 (big)



Wire Range	Color Code	Dimension' m/m	Part Number
22-18	Red	L25.0 W4.7	ITM PR
16-14	Blue	L25.0 W5.0	ITM PB
12-10	Yellow	L25.0 W6.9	ITM PY

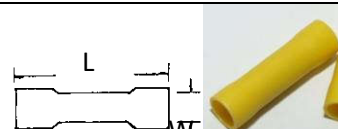

Only selective products are shown, please contact our sales for further inquiry. We have wide range of auto electrical parts from the following brands, **Our whatapps number 96232081.**

